

Marine and yachting catalogue

armare[®]
ropes

armare[®]
ropes



2017: Emirates Team New Zealand won the 35th America's Cup with ropes supplied by Armare Ropes

2021: The adventure goes on. Once again Armare is an official supplier to Emirates Team New Zealand to defend America's Cup.

Armare Ropes Official Supplier to Emirates Team New Zealand

**OFFICIAL
SUPPLIER** 2021
Defender America's Cup 36



Marine and yachting catalogue



“ARMARE” MEANS “TO PROVIDE A SHIP WITH ALL SHE NEEDS TO SAIL” OR “TO EQUIP A SAILING VESSEL”; THUS THE COMPANY’S NAME CONTAINS ITS VISION AS WELL AS A LINK TO ALL THOSE PRODUCTS ARMARE IS ABLE TO OFFER TO THE CUSTOMERS. FURTHERMORE, NOWADAYS THE BRAND ARMARE REPRESENTS THE CONTINUATION OF A LONG FAMILY TRADITION, WHOSE KNOWLEDGE HAS BEEN PASSED ON FROM FATHER TO SON.

Contents

INTRODUCTION

Company & Mission	06
Technical Fibers	08
Stretch & Creep	10
Treatments	12
Construction & Colours	14
Handcraft Finishes	16

ENDURANCE PROJECTS 18

PBO TW	22
Tecforce	22
Dyneforce Pure Black	23
Superound Pure Black	23
Shield Cores	24
Single Braids Shield Covers	26
	28

SUPER YACHT LINE 32

Dyneema® SK99 HPS PU + Covers	36
Dyneema® SK78 HPS PU + Covers	38
Captive Line	40

SUPER YACHT MOORING LINE 42

Storm Line Plus	44
Secur Line	45
Square Line PP	45
Storm Line	45
Round Line	45
Square Line	45

RACING LINE 46

Covers	47
Cores	48
Dyneforce 99 / 78	49
Dyneema® SK78 HPS PU + Covers	50
Dyneema® SK99 HPS PU + Covers	50

PERFORMANCE LINE 52

Dyneema® SK78 HPS PU + Covers	56
Dyneema® SK78 PU + Covers	58
Dyneema® SK78 + Covers	60
Vectran® PU + Covers	62

CRUISING LINE 64

Light 78 Plus	66
Light 78 Fast	66
Topspeed	66
Speedplus	66
Speedcruise	66
Star Plus	67
Star	67
Bora	67
Static	67
Armony	67

KITE & SURF 68

Dyneforce 99 for Kite	69
Kitedyne HPS	69
Kytedyne	69
Depower	69

CLASSIC LINE 70

Dyn 78 HPS PU - Pet	72
Light 78 Fast	72
Star	72
Fender Braid	72
Storm Line	73
Round Line	73
Square Line	73
Sea King	73

MOORING LINE 74

Secur Line	77
Novus Line	77
Square Line PP	77
Storm Line Plus	78
Storm Line	78
Round Line	78
Square Line	78
Sea King	78

ONE DESIGN LINE 80

<u>Optimist:</u>	
Gamberus 2.0 / 2.0 Plus	81
Downhaul	82
Outhaul	82
Complete Halyard System	82
Single Friction Block	82
Double Friction Block	82
Strops	82
Kit Optimist Strops	82
Gamberus Mainsheet	83
Optimist Halyard	83
Duck Line	83
Gamberus Full Kit Optimist	83
<u>One Design:</u>	
Zumba	84
Kumba 5-6-7	84
Hand Line	85
Lorenz Line	85
Duck Line	85
Dinghy Elastic	85
DynElastic	85
Stop 1	86
Stop 2	86
Stop 3	86
Stop 4	86

Stop 5	86
Stop 6	87
Run Line	87
Run Color	87
Colibri	87
Soft Braid 1-2-3-4-5-6-7	88

RIGGING LINE 90

Protection Covers	90
Supercable	91
Lumina Life Line	91
Zero Twist Cable	92
DynElastic	92
Lazy Line	92
Dyneema® Light Schakle	93
Unidir Loop	93
Dyneema® Sewing Thread	94
Waxed Pro	94
Lash Bobbin	94
Big Bobbin For Loop	94
T-Bone	95
Ronstan Tie Plastic Balls	95
Ronstan Halyard Plastic Balls	95
Coating PU	95
Electrical Heat-Cutter	95
Electronic Heat-Cutter	96
5 Needles for Sewing	96
10 Needles for Sewing	96
20 Needles for Sewing	96
Sail Repair Kit	96
Marlin Spikes	97
Splicing Kit Selma	97
D-Splicer Set	97
F-Series Needel	97
Special Scissors	97
Armare Splicing Tape	97

MULTIUSE LINE 98

Pet Minirolls	99
Dyneema® 100% Minirolls	99
Dyneema® / Pet Minirolls	99
Waxed Braid Minirolls	99
Minrolls Display	99
Fender Braid	100
Fantasy	100
Prorope	100
Sagola	100
Elastic	101
Delphinus	101
Engine	101
Multihull Dyneema® Net	101
Guardrail Net	101
Armare Shop Rack	102
Use and safety instructions	103

Armare Ropes

A company, a history, a mission

Following a long family tradition, Armare designs, manufactures and tests its products in Italy, in its facilities in San Giorgio di Nogaro (UD) – 4.000 Sq. m of twisting, stranding, braiding, different special treatments, splicing, testing and hand-finishing.

The wide range of Armare products includes technical solutions for both sailing and motor boats, but also cordage for aerospace, military, medical, sports, oceanographic, professional fishing and many industrial applications.

One of the hallmarks of Armare, is the ability to personalise the already wide range of products,

with custom finishes: this unique offer allows all operators, project managers, riggers, owners or shore-teams, to satisfy every POSSIBLE NEED.

Moreover Armare stands for reliability and safety, for the ability to make particular handmade finishings and splicings and last but not least for short delivery times.

To deal with an always quicker technological evolution and the advent of technical fibers, increasingly sophisticated and with extreme performance, Armare makes permanent investment in research and innovation to develop avant-garde solutions.

The collaboration with the most qualified riggers and the most renowned technician of the marine sector, has enabled Armare to supply composite-cables, running rigging and special textile accessories to the most famous sailing teams and prestigious shipyards. Armare is recognized as a leading company within the highest sectors.

Furthermore, starting from 2016, Armare has been selected as official supplier to Emirates Team New Zealand, winner of the 35th America's Cup

ARMARE PRODUCES A VAST RANGE OF ROPES, COMPOSITE CABLES, HIGH QUALITY RUNNING AND STANDING RIGGING EQUIPMENT, FOR RACING AND CRUISING SAIL BOATS, FOR MOTOR AND SAILING SUPER YACHTS. THE SPECIAL HANDCRAFTED FINISHES ARE ARMARE'S STRENGTH AND THE DISTINCTIVE CHARACTERISTIC OF ITS PRODUCTS.



A sustainable development

Since its establishment, Armare has undertaken a company policy of respect towards the territory in which it was founded and continues to work, protecting the environment, not only as far as its internal operations are concerned, but also considering the production materials, in strict accordance with the latest concepts of environmental sustainability and environmental friendliness. The recycling average of the Armare production chain is more than 96%.



Technical fibers

Conventional and basic fibers

There are two basic fibers most commonly used for the production of ropes: Polyester (PET) and Polyamide (PA).

Technical fibers

Other technical fibers are derived from the “aromatisation” of the basic fibers.

Fibers derived from Polyester:

- Vectran® (LCP)

Fibers derived from Polyamide:

- Kevlar®

- Twaron®

- Technora®

COMPARATIVE TABLE OF THE PROPERTIES OF THE FIBERS USED BY ARMARE

NAME	MATERIAL	TENACITY	ELONGATION	SPECIFIC GRAVITY	ATMOSPHERIC AGENTS RESISTANCE	ABRASION RESISTANCE	FUSION TEMP.
		[cN/dTex]	[%]	[Kg/dm ³]	[-]	[-]	[°C]
DYNEEMA® DM20	HMPE	35,1	3,5	0,975	Excellent	Very good	147
DYNEEMA® SK99	HMPE	42,5	3,2	0,975	Excellent	Very good	147
DYNEEMA® SK78	HMPE	35,1	3,5	0,975	Excellent	Very good	147
ZYLON®	PBO	37	2,5	1,56	Very poor	Little	660
KEVLAR® / TWARON®	ARAMID	20,8	2,4	1,44	Little	Poor	430
VECTRAN®	LCP	24,2	3,3	1,41	Poor	Little	330
TECHNORA®	ARAMID	22,3	4,0	1,39	Little	Poor	500
POLYESTER	PET	7,6	12,3	1,38	Good	Very good	260
HMPE NO BRAND	HMPE	29	4,0	0,97	Excellent	Good	144

UNDERSTANDING THE CHARACTERISTICS OF THE DIFFERENT FIBERS IS CRUCIAL FOR THE CORRECT CHOICE OF THE PRODUCT.

High performance technical fibers

Nowadays two further fibres are among the most important used for high performance applications. They are completely differing one another in chemical composition as well as in general technical characteristics.

Their acronyms are HMPE and PBO and their trade names are respectively:

- Dyneema®
- Spectra®
- Zylon®

Although the Dyneema® fiber is available in different types, it keeps constant basic characteristics and offers a wide range of performances when coupled to different covers.

LEARNING MORE ABOUT THE DIFFERENT FIBERS

CONVENTIONAL BASIC FIBERS	TECHNICAL FIBERS	HIGH PERFORMANCE TECHNICAL FIBERS
PET (POLIESTERE) DACRON® TREVIRA® DIOLEN®	LCP VECTRAN®	HMPE DYNEEMA® SPECTRA®
PA (POLYAMIDE) NYLON® ENKALON® PERLON®	ARAMID KEVLAR® TWARON® TECHNORA®	PBO ZYLON®

Stretch & Creep

The real performance is inside the rope

The outside of many ropes looks exactly the same. Of course, most of the running rigging are protected by a cover to improve the resistance to abrasion and to increase the grip on the winch though the load is carried by the core. Fibers used for the inside of the rope can be pre-stretched and PU coated.

Above all, the core can be constructed with different fibers to take the load. Choose the right cover is important to improve the performance of the rope and depends on the use and the accessories which are applied to.

MATERIAL TECHNOLOGY COMPARISON

	DYNEEMA® SK99	DYNEEMA® SK78	DYNEEMA® DM20	HMPE	VECTRAN®	POLIESTERE
<u>Perfect fit for</u>	Best in class racing performance	Industry standard for running rigging lines	Standing rigging and ropes under constant tension	Cruising boat	Ideal under static loads and optimal for steering line systems	Daily Cruiser
Lightweight at the same strength	•••••	•••••	•••	•••••	•••	•
Responsiveness	•••••	•••••	•••	•••	•••••	•
Stretch (reversible elongation)	•••••	•••••	•••••	•••	•••••	•
Creep (irreversible elongation)	•••	•••	•••••	•••	•••••	•••

- Poor
- Enough
- Good
- Very Good
- Excellent

THERE ARE MANY WAYS TO CONSTRUCT A ROPE;
 DEPENDING ON THE CONSTRUCTION AND WHETHER
 THERE IS AN OPTIMAL USE OF THE FIBERS,
 YOU'LL BE ABLE TO NOTICE DIFFERENT ELONGATIONS.

Stretch

The stretch is a **reversible elongation of the fiber**. The words “elongation” and “stretch” have the same meaning and indicate the phenomenon related to the fibers of a rope that, when subjected to tension, return to their original length when the tension is released. This phenomenon is called “reversible lengthening” or “elastic”. The elongation of the fiber is related to the specific “modulus” of the same and indicates how much resistance the fiber is able to oppose to elongation. The higher the value of the modulus, the lower the elongation.

Creep

Creep is an **irreversible elongation of the fiber**. It is the characteristic of the fiber with which the rope has been made. The fiber creeps when subjected to a constant load for a given time. The result is irreversible and is called “plastic elongation”. This deformation depends on the applied load, on the time which the load is maintained and on the temperature. The higher the temperature to which the line is subjected, the greater the elongation of the rope.

Low stretch ropes

When a halyard or a sheet elongates, the sail loses its correct airfoil, so the boat cannot accelerate and fully exploit its power. Furthermore, the more elastic the rope, the more energy it absorbs. This energy is taken away from the sail: the loss of energy affects acceleration, especially in gusty conditions, with the result of a continuous need for adjustment of the rope / sail and with appreciable reductions of navigation performance.



TECHNICAL FIBERS: ELONGATION AT BREAK

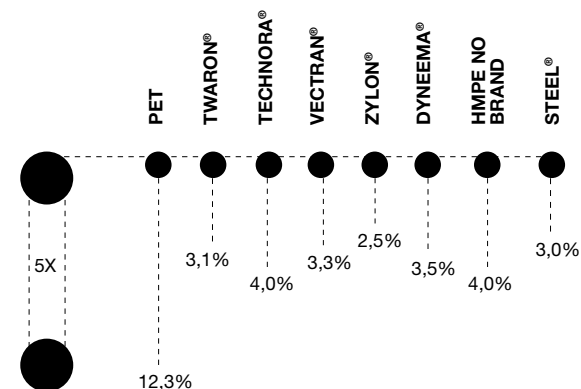

Synthetic fibers tested in accordance with ISO 2062

RESIDUAL STRENGTH OF TECHNICAL FIBERS

% of original tenacity after 336 hours of exposure to atmospheric agents

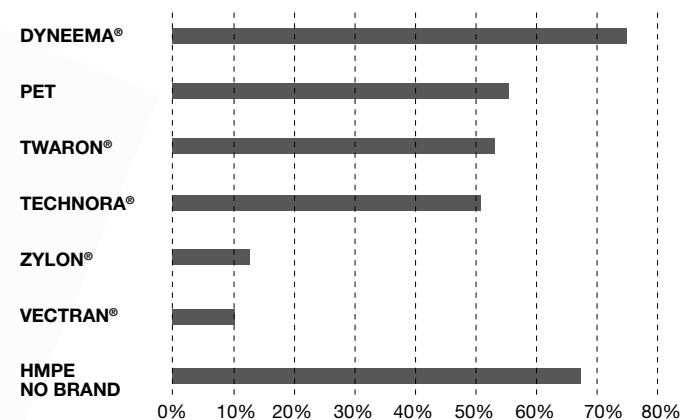

Simulation of aging according to standard ASTM G-155
Synthetic fibers tested in accordance with ISO 2062

Treatments

/ HPS
/ Shield
/ Captive
/ PU

DIFFERENT SPECIAL TREATMENTS MAY BE APPLIED TO THE BRAIDED CORES TO ENHANCE THEIR CHARACTERISTICS IN TERMS OF ELONGATION, CREEP AND RESISTANCE, AND TO OBTAIN THE BEST PERFORMANCE FROM EACH TYPE OF FIBRE.



HPS treatment

The Heat Prestretch Setting regulates the tensioning of the fibers that make up the rope and sets them in an optimal way, bringing them to a high temperature and subjecting them to a constant load for a given time. The result is a rope with a **very high specific modulus**, without construction elongation and a higher breaking load, if compared with non-prestretched ones. Furthermore, the rope is much **more compact, less flexible and therefore thinner** than a rope with the same non-prestretched core. The choice to buy a rope undergone to the HPS treatment

depends on the type and on the technical level of the boat, anyway it is to be preferred on halyards. In this application, the slightly higher stiffness of the ropes will not be a problem, as they are used much less than other lines. On high-level racing boats, almost all the running rigging is made with pre-stretched ropes.



Single braid Dyneema® without HPS treatment: the braid is soft and "airy".



The braid after the HPS treatment: the fibers are oriented and the rope is more rigid and compact.



Shield treatment

“Shield” is the name given to a special unifilar impregnation treatment applied to the Dyneema® fiber by using a **very special protective coating that creates a kind of “Shield” all around the pure fiber** (that’s how the treatment got its name). Apart from reducing the exposure of the fibers to UV rays thanks to its opaque pigments, it also lowers remarkably the friction between the fibers themselves, usually caused by the load applied to the ropes and/or by the movement and bending around the pulleys. Besides the mentioned points, it has been proved that “Shield” increases significantly the fatigue and flexion cycles of the ropes realized in Dyneema®. Results are shown on the next pages.



Captive treatment

This treatment is applied to all kind and size of rope designed for the application on captive winches. The **complete adherence of core and cover** is guaranteed even after countless cycles of winding and unwinding of the rope on the drum as well as after the run through different drive gears.

To avoid any formation of those undesirable slacks between core and cover, the “Captive” treatment must always go with a careful and precise production and finish of the rope/maneuver by the rigger who works it.



PU treatment

Thanks to the impregnation with the Polyurethane Coating specifically developed for this fiber, the single braid in Dyneema® gains remarkable advantages in terms of **compactness, reduction of compression under load** and as a consequence, the rope preserves its **roundness**.

This coating becomes even more important when the ropes have to be worked and/or when the cover has to be removed as the polyurethane keeps the Dyneema® fibers linked; this increases the quality of the product in terms of durability and abrasion resistance.



Armare colour system

THANKS TO THE EXCLUSIVE ARMARE COLOUR SYSTEM, LOOK (OR CONSTRUCTION) AND COLOUR OF THE ROPES CAN BE CUSTOMIZED. THE DOPE-DYED HIGH TENACITY POLYESTER GUARANTEES A LOW ELONGATION, LIGHT FASTNESS AND A GOOD RESISTANCE TO ATMOSPHERIC AGENTS AND ABRASION.

Constructions and Colours

Ropes, especially the technical ones, can be single braid or double braid. In the first case, the fiber (typically Dyneema®) is left without cover. In the second case, the fiber is protected by a second layer (the cover) with protective functions, but also to make the rope more manageable and with a better grip. The color, or mix of colors of the sock can be chosen among the many available, following the indications on the composition, by taking into consideration the type of construction and the fiber.

Single braid



Some ropes, like Vec-Tec and Dyneforce have a single braid construction. They are very easy to splice.

Double braid



This is the most widely used type of construction, with an internal braided core and a protective outer braid. They are medium-difficult to splice.

Colours of the technical fibers



Dyneema®



Vectran®



Kevlar®



Gold Technora®



PBO-Zylon®



Black Technora®



Cordura® + Polyester

PET colours



01 White



02 Black



03 Anthracite



04 Silver Grey



05 Brown

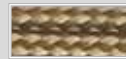

06 Hemp



07 Beige



08 Yellow



09 Fluo Yellow



10 Red



11 Orange



12 Fluo Orange

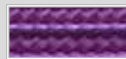

13 Violet



14 Bordeaux



15 Green



16 Fluo Green



17 English Green



18 Military Green



19 Azure



20 Sea Blue



21 Navy Blue

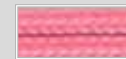

22 Pink



24 Japan Orange

Constructive mix for double braid ropes

Solid Colour

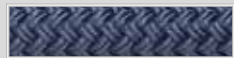

The cover in solid color is entirely manufactured with PET. Choose the color from our standard color palette or from the special colors.

Fleck 1



The cover is entirely manufactured in solid color PET with one colored fleck. Choose the color for the base as well as the color for the fleck from our standard color palette or from the special colors.

Fleck 2

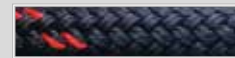

The cover is entirely manufactured in solid color PET with two colored flecks. Choose the color for the base as well as the color for the flecks from our standard color palette or from the special colors.

Marker



The cover is usually entirely manufactured in solid white PET with colored flecks. You may also choose a different color for the cover as well as the quantity and color of the markers from our standard color palette or from the special colors.

Mix

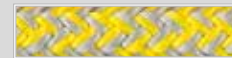

The cover is manufactured in PET and the design is formed by combining 2 different but paired colors.

Snake



The cover is manufactured in PET by using 2 different colors to obtain a snake pattern.

Melange

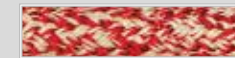

The cover is composed by different colors that have been coupled previously.

Melange Techno



Melange Techno covers are made of random mixed, technical fibers. The final result is a mixture of natural colours, influenced only by the percentage of each fiber, part of composition.

Handcraft Finishes

ARMARE ROPES OFFERS MANY HANDCRAFTED FINISHES ON THE ROPES THAT CAN BE CUSTOMIZED WITH SPLICES, PROTECTIONS OR WITH THE APPLICATION OF THIMBLES AND OTHER TERMINALS ACCORDING TO SPECIFIC REQUESTS.

Main advantages with handcraft finishes

Maintainance of almost the overall load performance.

Immediate and practical final use of the rope.

Preparation for prolonged use, without further action. (ex. the “milking” of the sock to eliminate slacks created with use).

Pre-settling of the rope: splicing requires the application of a minimum traction load, that alligns the fibers and stretches them.

Splices, lashings, taperings

Ropes often require some splicing or different finishes, depending on the intended use, whether on board of the boat, for the use by sailmakers, for industrial application or for security purposes. These special processes are carried out by Armare, either at its laboratory or directly on board: they are very accurated both technically and aesthetically.

Important notes on splicing

For each type of construction of the lines, there is a different method of splicing (i.e. the creation of a loop on one or both ends of the line), designed to minimize the loss of breaking load which results from this process. An accurately constructed splice retains 80% to 90% of the breaking load of a brand new rope. An incorrect splice, can reduce the breaking load of a brand new rope by more than 60%; this means that the suggested working load of the rope is very close to the breaking load. This also applies to knots that can halve the strength of the rope, as the fibers are strangled against each other, cutting themselves where the pressure is the highest.

Available Splices

Single Braid



Eye splice single braid
Code L01



Eye splice on stainless thimble
single braid / Code L04



Splice on lash bobbin single braid
Code L09

Double Braid



Eye splice without cover double braid
Code L02



Eye splice without cover on stainless thimble
double braid / Code L05



Eye Splice without cover on lash bobbin
double braid / Code L10



Eye splice with cover double braid
Code L03



Eye splice with cover on stainless thimble
double braid / Code L06



Eye Splice with cover on lash bobbin
double braid / Code L11

Available Finishes



Tapering on double braid
Code L07



Halyard spliced loop for mousing line
Code L14



Whipping on rope end
Code L16



Dyneema® TIP on double braid
Code L08



Halyard sewn loop for mousing line
Code L15



Sewed by sewing machine
Code L26

NEW

Endurance projects

Endurance
projects

SINGLE BRAID

Tecforce

Treatments: PU

PBO TW

Treatments: PU

Dyneforce Pure Black

Treatments: HPS / PU

Superound Pure Black

Treatments: PU

AVAILABLE CORES

Dyneema® DM20 SHIELD

Treatments: HPS / SH

Dyneema® SK99 SHIELD

Treatments: HPS / SH

Dyneema® SK78 SHIELD

Treatments: HPS / SH

Dyneema® SK78 SHIELD

Treatments: SH

AVAILABLE COVERS

PBO-Zylon®

PBO

PBO-Zylon®

Black Technora®

PBO / BTEC

PBO-Zylon®

Black Dyneema®

PBO / CDYN

PBO - Zylon®

Black Technora®

Black Dyneema®

PBO / BTEC / CDYN

Black Technora®

Black Dyneema®

BTEC / CDYN

Black Technora®

Black Dyneema®

Polyester

BTEC / CDYN / PET

THE PRODUCTS SHOWN IN THIS SECTION ARE THE RESULT OF SEVERAL TESTS AND FEEDBACK RECEIVED FROM THE BEST RIGGERS, SHORE-TEAMS AND CREWS OF THE MOST PRESTIGIOUS RACING BOATS WORLDWIDE.



Last generation treatments

Armare, always at the forefront of research and testing of new materials, proposes innovative solutions to keep the color of the used fibers as stable as possible, while ensuring a high protection of the fibers.

Pure Black Dyneema®



The best solution to defeat the colour from the UV rays.

Thanks to the new entry of Dyneema® BK (BLACK), nowadays we are able to produce a black rope totally made with Dyneema® without degradation of colour. **Dyneema® BK is dope-dyed** i.e. black colour pigments are added to the fibre while extruded. This process allows to obtain a stable and long lasting coloring of the fibre without any compromise in terms of durability and resistance to UV rays.

Shield Treatment



The highest protection against the wear.

The other type of treatment introduced by Armare is the Shield Treatment. In this case the external surface of the fibre **is colored / impregnated**; in fact, when cutting it you will notice that the inner fibre is white. This procedure allows the perfect distribution of the coating over the entire surface of the fiber, enhancing the quality of the finished product, both from a technical and aesthetical point of view. The **shield created by this treatment**, from which the name "Shield" derives, also brings a noticeable improvement in terms of duration of the rope, thanks to the increased compactness and resistance to abrasion.

Differences between pigmenting

The difference between pigmenting through the “dope-dyed” process and dyeing the yarn made with Dyneema® fiber through any other coloring process can be summarized as explained on the right.

We can point out that the “DOPE-DYED” coloring allows to obtain a stable and durable black colour with a slight loss of technical performance in terms of breaking load. Coloring by impregnation with “SHIELD” treatment on the single-strand fiber is less durable in terms of resistance of the pigment to the light, but it doesn’t affect the performance of Dyneema® fibers as it doesn’t interfere with its molecular structure. This treatment rather improves some of the characteristics of the final rope, especially the reduction of the phenomenon known as “yarn to yarn friction”, as to say the friction that occurs between the fibers when subjected to loading and repeated movements.

Dope-Dyed process (Pure Black Dyneema®)

The fiber is colored in and out i.e. when slicing it you will see that the color is uniformly present on the whole surface of the sectioned filament.

Dyneema® filament
Dope-Dyed

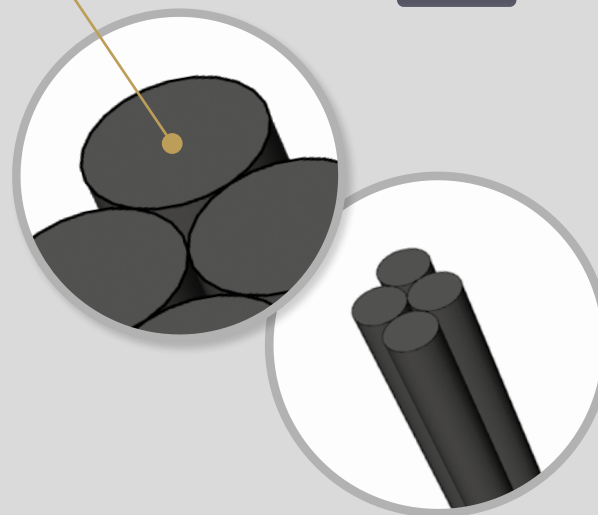

The Dyneema® filaments are fully impregnated with pigment during the spinning (Dope-Dyed) and the result is a solid colour that is the same in and outside the base filament.

Shield process

The basic fiber is impregnated with a coating that dyes it only externally. I.e.: when slicing it, the inner side is white while the external surface is pigmented.



Shield treatment
2 µm tickness

Dyneema® filament



The Dyneema® filaments are spinning in a raw/natural colour and in a second phase they are coated with a special coating blend PU based.

Single Braid

PBO TW (PBO-Zylon® + PU)

Designed to equip the best sail boats, PBO-Zylon® guarantees the lowest elongation, a high breaking load, elevated mechanical resistance and optimal flexibility. Moreover, the elevated stability on winches and stoppers, the lightweight and its good handling make this rope the excellent partner of the most demanding crews.



CODICE PRODOTTO NA56C00

CONSTRUCTION

12 plait with PBO-Zylon® impregnated with polyurethane coating.

USE Ideal for strops, tackles and underdeck low elongation manoeuvres, or used inside machines or covered by carters which protect from the UV exposure.

DIAMETRI STANDARD

From 3 to 15 mm.
Other diameters on request.

STRETCH AT 30% B. L. 1,80%

STRETCH AT B. L. 2,85%

COLOUR Black.



Black

PBO TW SINGLE BRAID		
NA56C00		
DIAM	B. L.	WEIGHT
[mm]	[daN]	[g /m]
3	1.260	6,50
3,5	1.680	8,80
4	2.220	13,00
5	3.500	20,00
6	4.750	27,00
7	6.600	37,00
8	8.640	52,00
9	10.500	61,00
10	12.830	78,00
11	14.420	92,00
12	17.100	110,00
13	19.000	125,00
14	21.000	140,00
15	23.400	157,00

Tecforce (Black Technora® + PU)

NEW

Particularities of this aramid fiber are its good resistance to UV rays and to bending if compared to other standard aramid fibers; both properties allow to obtain long lasting ropes with a good breaking load and a low elongation. A very oriented molecular structure guarantees a high modulus with a low creep. Tecforce is therefore mainly used for bindings, reinforcements as well as for all those applications where an important breaking load but also a high resistance to abrasion and elongation are required.



PRODUCT CODE TA52C00

CONSTRUCTION

12 plait with Black Technora® 100% impregnated with polyurethane coating.

USE Ideal for tackles and for bindings where high abrasion and UV resistance are required.

STANDARD DIAMETERS

From 4 to 14 mm.
Other diameters on request.

STRETCH AT 30% B. L. 2,95%

STRETCH AT B. L. 4,45%

COLOUR Black.



Black

TECFORCE SINGLE BRAID		
TA52C00		
DIAM	B. L.	WEIGHT
[mm]	[daN]	[g /m]
4	1.880	12,00
5	2.650	18,00
6	3.170	25,00
7	4.750	27,90
8	6.336	45,00
9	7.168	60,00
10	8.000	74,00
11	10.000	80,00
12	12.000	85,00
14	16.850	107,00

Single Braid

Dyneforce Pure Black

NEW

The already well-known performances of our former Dyneforce75 (replaced by Dyneforce 78) will be proposed again yet in its new version Dyneema® SK 75 BK. The main characteristic of this fiber, named Dyneema® Pure Black, consists in having a colour that can't be attacked by any agent, since the fiber is dope-dyed (see page 20). Besides its remarkable technical performances, the aesthetic is given by the colour that won't fade over time.



PRODUCT CODE NA77C00_CDY

CONSTRUCTION

12 plait with Dyneema® SK75 Pure Black impregnated with polyurethane coating and special heat treatment HPS.

USE All use as a standard Single Braid in Dyneema® but with a structural solid colour.

STANDARD DIAMETERS

From 3 to 14 mm.
Other diameters on request.

STRETCH AT 30% B. L. 2,16%

STRETCH AT B. L. 3,20%

COLOUR Pure Black.



Pure Black

Ø	DYNEFORCE PURE BLACK SINGLE BRAID	
	NA77C00_CDY	
DIAM	B. L.	WEIGHT
[mm]	[daN]	[g /m]
3	1.068	6,80
3,5	1.400	8,20
4	2.250	10,10
5	2.980	15,30
6	5.000	24,00
7	6.400	31,10
8	8.200	38,20
9	9.500	51,10
10	11.600	60,00
11	13.100	77,00
12	16.000	94,00
13	17.780	110,00
14	20.000	128,00

Superound Pure Black

NEW

The renewed version of this specific item, made with Dyneema® SK75 BK (or Dyneema® Pure Black) maintains its basic features and on top of that the fiber is dope-dyed (see explanation at page 20). The result is a long-lasting colour that doesn't fade over time, while excellent technical performances are guaranteed.



PRODUCT CODE NA67C00_CDY

CONSTRUCTION

12 plait with Dyneema® SK75 Pure Black impregnated with polyurethane coating.

USE All use as a standard Single Braid in Dyneema® but with a structural solid colour.

STANDARD DIAMETERS

From 3 to 14 mm.
Other diameters on request.

STRETCH AT 30% B. L. 2,60%

STRETCH AT B. L. 3,60%

COLOURS Pure Black.



Pure Black

Ø	SUPEROUND PURE BLACK SINGLE BRAID	
	NA67C00_CDY	
DIAM	B. L.	WEIGHT
[mm]	[daN]	[g /m]
3	730	5,00
3,5	1.100	7,50
4	1.530	9,80
5	2.300	14,40
6	3.230	20,00
7	4.560	27,00
8	6.100	35,00
9	7.270	46,00
10	9.000	57,00
11	10.200	61,00
12	12.000	68,00
13	13.250	73,00
14	14.500	78,00

Shield Cores



NEW

Dyneema® DM20 HPS / SHIELD



Dyneema® DM20 has been created to satisfy specific marine/industrial needs. Compared to other types of Dyneema®, it shows better performance in terms of durability over time as well as a close to zero creep. Its very stable construction allows Armare to produce a rope that is suitable for all those applications where a constant load and a continued use would put to the test any other type of Dyneema®. Furthermore, the Shield treatment increases the compactness and the abrasion resistance of this rope.

NEW

Dyneema® SK99 HPS / SHIELD



Dyneema® SK99 delivers the highest tenacity available in a light weight polymer fiber. Indeed, compared to Dyneema® SK78, it shows a 20% increase on tenacity and a 35% higher modulus. Dyneema® SK99 appears thinner and lighter weight respect to ropes with the same diameter, but with a significant increase in strength, which entails an increase on performance and a better response of the boat. Moreover, thanks to the application of the Shield treatment, the ropes results more compact and more resistant to abrasion. Other features: low water absorption, high UV resistance, minimal elongation and good flexibility.

NEW

Dyneema® SK78 HPS / SHIELD



The High Modulus fiber Dyneema® SK78, characterized by a remarkable stability under constant loads, provides the following features: low creep and elongation, elevated breaking load, light weight, low level of water absorption, high resistance to UV rays, great flexibility. Furthermore, the Shield treatment increases the compactness and the abrasion resistance of this rope. The ropes made with this core are destined to extreme performances, especially during highly demanding regattas when the permanent load is continuously present.

NEW

Dyneema® SK78 SHIELD



This Line of ropes differs from the previous version Dyneema® SK78 + HPS + SHIELD in the lack of the HPS treatment, which means that there is no thermic pre-stretching under load. This makes the rope more manageable, as the core is more supple. It has a slightly different breaking load and elongation in comparison with DYN 78 + HPS + SHIELD, because the braid is not settled (it means that the differences of tensions between fibers are not adjusted). However, its general features remain at a high level, making this rope affordable to boats and crews of a less extreme technical level.



Dyneema® DM20

/ Features

The result of the comparison of Dyneema® DM20, SK99, SK78 and SK75 in identical physical and environmental conditions shows the better performance of DM20 in terms of durability over time as well as a close to zero creep.

ARMARE DYNEFORCE TYPES COMPARISON

	Dyneema® DM20	Dyneema® SK99	Dyneema® SK78	Dyneema® SK75
Creep	Zero	••	•	•••
Elongation	•	•	•	•
Endurance life	•••••	•••••	•••••	•••••
Rope weight in comparison with B.L.	••••••	•••	•••••	•••••
Strenght	••••	••••••	•••••	•••••

Characteristics as the about to zero creep, main feature of **Dyneema® DM20** enhanced by the very stable single braid construction as well as by the specific polyurethane coating and HPS treatment (heat pre-stretch treatment) allow Armare to produce a rope that is suitable for all those applications where a constant load and a continued use would put to the test any other type of Dyneema®.

CREEP ELONGATION / DM20 (MAX TECHNOLOGY) VERSUS SK75 - SK78 FIBER

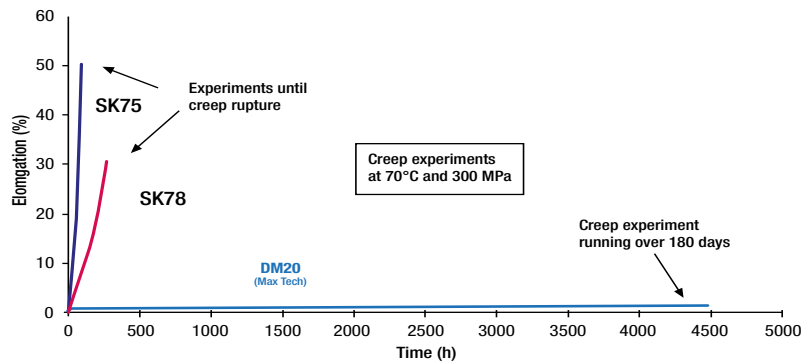

Dyneforce Comparison

/ Shield vs Standard

First and foremost we highlight that the test shown below has been performed in-house on two items, produced by Armare, having equal diameters and identical constructions. The results obtained at the bending fatigue test, both the ropes have been submitted to, complete the chart of technical characteristics and are extremely interesting for both, designers and professional riggers who wish to recommend and supply high-performance products to their customers.

BENDING FATIGUE TEST COMPARISON / DYNEFORCE SK78 VS DYNEFORCE SK78 SHIELD

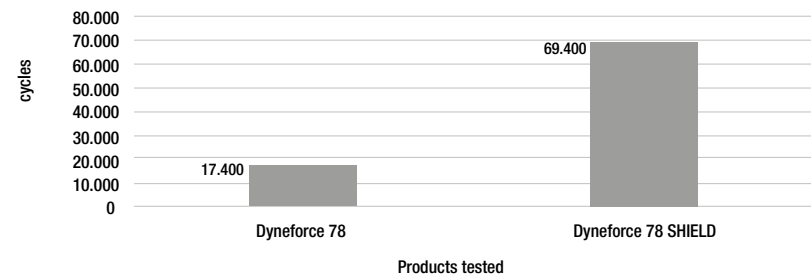

NOTE: The above test was made in Armare facilities on new 8 mm ropes, same construction and same test conditions

Thanks to the “Shield” treatment we can guarantee high resistance to bending and on top of that, added to characteristics like high breaking load, high modulus, low creep, high resistance to UV rays and last and not least a very low specific weight, these ropes are the best alternative to traditional wire ropes used in the marine industry and beyond.

Single Braid SHIELD



SINGLE BRAIDS + SHIELD - BREAKING LOAD AND WEIGHT COMPARATIVE TABLE

Ø	DYNEFORCE DM20 SHIELD SINGLE BRAID		DYNEFORCE 99 SHIELD SINGLE BRAID		DYNEFORCE 78 SHIELD SINGLE BRAID		SUPERROUND 78 SHIELD SINGLE BRAID	
	NA25S_C00		NA20S_C00		NA58S_C00		NA17S_C00	
DIAMETER	B. L.	WEIGHT	B. L.	WEIGHT	B. L.	WEIGHT	B. L.	WEIGHT
[mm]	[daN]	[g /m]	[daN]	[g /m]	[daN]	[g /m]	[daN]	[g /m]
3	1.237	4,90	1.516	6,08	1.455	4,95	966	5,05
3,5	1.465	7,12	2.310	9,73	1.724	8,28	1.071	7,58
4	2.008	9,28	2.940	11,31	2.363	10,20	1.680	9,90
5	2.755	14,06	4.496	18,23	3.241	15,45	2.940	15,10
6	4.458	19,76	6.510	23,09	5.245	24,24	4.305	20,20
7	5.712	27,90	8.484	27,78	6.720	31,41	6.405	27,27
8	6.605	35,86	10.328	39,19	7.770	38,59	7.508	35,35
9	8.672	42,95	13.068	48,62	10.202	51,62	8.505	46,46
10	10.353	50,00	15.414	59,39	12.180	60,61	10.710	57,58
11	11.692	62,50	17.320	62,63	13.755	77,78	12.705	61,62
12	14.280	75,80	19.131	77,78	16.800	94,95	15.960	68,69
13	15.869	100,60	23.286	96,18	18.669	111,11	17.535	73,74
14	17.850	106,30	27.384	111,11	21.000	129,29	18.743	78,79
15	20.528	112,80	31.500	130,30	24.150	145,45	21.525	90,91
16	23.473	119,25	38.850	146,46	27.615	161,62	23.100	103,03
17	25.883	139,70	41.937	164,20	30.450	181,87	24.780	115,20
18	28.025	160,10	44.835	181,82	32.970	202,02	26.250	127,27
19	29.988	185,10	48.195	199,60	35.970	227,09	27.878	144,64
20	33.023	210,00	51.975	218,00	38.850	252,00	30.135	162,00

NOTE ABOUT BREAKING LOAD AND DIAMETERS The average values shown above are derived from tests taken at Armare laboratory, on properly spliced new ropes, and may change without notice. Other diameters available on request. The static load of the rope must not exceed 20% of breaking load shown in the table. Knots may affect the breaking load of the rope with reductions of up to 60%. The splicing increases the diameter of the rope of about 1.5 times. The use and exposure to weather conditions, depending from the kind of rope and the time of exposure, can reduce the breaking loads of the ropes.



Dyneforce DM20 SHIELD

Single Braid

PRODUCT CODE NA25S_C00



CONSTRUCTION 12 plait with Dyneema® DM20 impregnated with SHIELD coating and special heat treatment HPS.

USE It is the ultimate solution for strops, shrouds, backstays and halyards on hydraulic cylinder but also for stable and long-lasting bindings.

STANDARD DIAMETER From 3 to 20 mm.

STRETCH AT 30% B. L. 2,16%

STRETCH AT B. L. 3,20%

COLOURS Silver Grey.



Silver Grey

Dyneforce 99 SHIELD

Single Braid

PRODUCT CODE NA20S_C00



CONSTRUCTION 12 plait with Dyneema® SK99 impregnated with SHIELD coating and special heat treatment HPS.

USE Ideal for tackles, backstays, runners, baby stays, halyards on hydraulic cylinders, strops and loops; moreover for bindings where high breaking load, low elongation and minimal amount of space are required.

STANDARD DIAMETERS From 3 to 20 mm.

STRETCH AT 30% B. L. 1,65%

STRETCH AT B. L. 2,80%

COLOURS Black, Silver Grey.



Black



Silver Grey

Dyneforce 78 SHIELD

Single Braid

PRODUCT CODE NA58S_C00



CONSTRUCTION 12 plait with Dyneema® SK78 impregnated with SHIELD coating and special heat treatment HPS.

USE Ideal for tackles, backstays, runners, baby stays, control lines, strops and loops; moreover for bindings where a good breaking load and a low elongation are required.

STANDARD DIAMETERS From 3 to 20 mm.

STRETCH AT 30% B. L. 2,10%

STRETCH AT B. L. 3,15%

COLOURS Black, Silver Grey.



Black



Silver Grey

Superound 78 SHIELD

Single Braid

PRODUCT CODE NA17S_C00



CONSTRUCTION 12 plait with Dyneema® SK78 impregnated with SHIELD coating.

USE Ideal for bindings, leading blocks, control lines and tackles.

STANDARD DIAMETERS From 3 to 20 mm.

STRETCH AT 30% B. L. 2,55%

STRETCH AT B. L. 3,55%

COLOURS Black, Silver Grey.



Black



Silver Grey

Covers

Covers



SIX HIGH PERFORMANCE COVERS COMPLETE AND ENHANCE ARMARE'S ENDURANCE LINE. THEY ARE MADE OF THE MOST SOPHISTICATED FIBERS AND HAVE BEEN DEVELOPED AND TESTED ON THE MOST PRESTIGIOUS

RACING BOATS WORLDWIDE

Available Covers

PBO - Zylon®

PBO

Unbeatable resistance to abrasion and heat. Thanks to its properties, it is the best choice among the range of technical ropes in the applications where high temperatures and elevated loads are constantly present.

NEW

PBO - Zylon® / Black Dyneema®

PBO / CDYN

Thanks to the presence of PBO®, this cover has a high resistance to abrasion. The right mix with Dyneema® fibre transfers a good fluidity to the ropes when released on winch under load. Tests on racing boats have demonstrated the amazing durability to high frequency movements of the cover. The presence of Pure Black Dyneema® gives this cover a technical look, compliant to the design of the best racing yachts.

NEW

PBO - Zylon® / Black Technora®

PBO / BTEC

First rate resistance to abrasion and high temperature. Thanks to the balance of two excellent fibers its properties are perfect for the intensive uses onboard of the competitive yacht racing.

NEW

PBO - Zylon® / Black Technora® / Black Dyneema®

PBO / BTEC / CDYN

This cover is the ideal choice for running rigging subjected to high loads or high temperatures. Moreover, it is suitable for all those manoeuvres where very fast recoveries are necessary as it avoids the melt of the fibers and damages that affect the life of the cover. The mixture of three different high-performance fibers guarantees a remarkable durability and smoothness as well as an excellent resistance to abrasion and heat, thanks to the high melting point of the basic fibers.

NEW

Black Technora® / Black Dyneema®

BTEC / CDYN

The mixture of these fibres has been carefully studied to be fairly distributed in order to make them take advantage of their mutual characteristics, both in terms of durability and performance. Excellent results in order of smoothness, abrasion resistance and durability have been reached. The presence of Pure Black Dyneema® gives this cover a solid black colour, accordant to the needs of the top racing yachts.

NEW

Black Technora® / Black Dyneema® / Polyester

BTEC / CDYN / PET

This item is suitable for many different boats and uses because of its excellent resistance to abrasion and to repeated bending. Compared to TEC/DYN covers, it is easier to customize thanks to the presence of Polyester and it even becomes more recognizable in the distinction of the different manoeuvres. Furthermore, the use of the Pure Black Dyneema® gives this cover a solid black colour, accordant to the needs of the top racing yachts.

Endurance Covers



PBO Zylon® PBO (C56)



DESCRIPTION AND USE:

This cover is especially used for runner tackles, high friction/load sheets and also for hi-loads tackles.

DM20 SHIELD - BREAKING LOAD AND WEIGHT COMPARATIVE TABLE *

Ø	FOR ALL COVERS	PBO	PBO/CDYN	PBO/BTEC	PBO/BTEC/CDYN	BTEC/CDYN	BTEC/CDYN/PET
	NA25S	C56	C56_CDY	C74	C75_CDY	C35_CDY	C85_CDY
DIAM	B. L.	WEIGHT	WEIGHT	WEIGHT	WEIGHT	WEIGHT	WEIGHT
[mm]	[daN]	[g /m]	[g /m]	[g /m]	[g /m]	[g /m]	[g /m]
4	848	13,72	12,70	12,80	12,70	12,52	12,30
5	1.237	21,28	19,60	19,80	19,60	19,19	19,00
6	2.008	29,05	26,80	27,00	26,80	26,50	26,16
7	2.382	42,44	39,10	39,50	39,10	38,22	38,22
8	2.755	55,62	51,30	51,80	51,30	50,80	50,08
9	4.458	67,55	61,80	62,40	61,80	61,30	60,37
10	5.087	79,38	73,10	73,80	73,10	72,50	71,34
11	6.158	97,20	89,60	90,50	89,60	88,80	87,51
12	7.631	112,86	104,00	105,00	104,00	103,10	101,53
13	8.672	132,18	121,77	123,00	121,77	121,00	119,00
14	9.014	151,85	139,90	141,20	139,90	138,70	136,51
15	10.353	176,53	162,65	164,20	162,65	161,25	158,76
16	11.692	201,20	185,40	187,20	185,40	183,80	181,00
17	12.941	219,12	202,00	203,92	202,00	200,20	197,80
18	14.280	236,95	218,40	220,50	218,40	216,50	213,15
19	15.869	265,78	245,70	248,64	245,60	243,55	239,81
20	17.850	294,60	273,00	276,77	272,80	270,60	266,46

* NOTE ABOUT BREAKING LOAD AND DIAMETERS The average values shown above are derived from tests taken at Armare laboratory, on properly spliced new ropes, and may change without notice. Other diameters available on request. The static load of the rope must not exceed 20% of breaking load shown in the table. Knots may affect the breaking load of the rope with reductions of up to 60%. The splicing increases the diameter of the rope of about 1.5 times. The use and exposure to weather conditions, depending from the kind of rope and the time of exposure, can reduce the breaking loads of the ropes.

DYN 99 HPS SHIELD - BREAKING LOAD AND WEIGHT COMPARATIVE TABLE *

Ø	FOR ALL COVERS	PBO	PBO/CDYN	PBO/BTEC	PBO/BTEC/CDYN	BTEC/CDYN	BTEC/CDYN/PET
	NA20S	C56	C56_CDY	C74	C75_CDY	C35_CDY	C85_CDY
DIAM	B. L.	WEIGHT	WEIGHT	WEIGHT	WEIGHT	WEIGHT	WEIGHT
[mm]	[daN]	[g /m]	[g /m]	[g /m]	[g /m]	[g /m]	[g /m]
4	1.516	13,82	12,83	12,93	12,42	12,55	12,42
5	2.310	21,49	19,80	20,00	19,19	19,38	19,19
6	2.940	29,34	27,07	27,27	26,23	26,77	26,23
7	3.675	42,87	39,49	39,90	38,60	39,19	38,60
8	4.496	56,18	51,81	52,32	50,58	51,31	50,58
9	6.510	67,74	62,42	63,02	60,97	61,91	60,97
10	7.508	80,17	73,83	74,54	72,05	73,23	72,05
11	9.398	98,17	90,50	91,41	88,39	89,69	88,39
12	10.328	113,99	105,04	106,05	102,55	104,13	102,55
13	10.710	133,68	123,17	124,33	120,38	122,11	120,38
14	13.068	153,37	141,30	142,61	138,21	140,09	138,21
15	15.141	178,29	164,28	165,84	160,51	162,86	160,51
16	16.328	203,22	187,25	189,07	182,81	185,64	182,81
17	17.320	221,27	203,98	205,97	199,51	202,20	199,51
18	19.131	239,22	220,58	222,71	215,28	218,67	215,28
19	23.286	268,50	248,16	249,46	244,47	246,00	242,25
20	27.384	297,00	275,73	276,20	273,66	273,31	269,12

PBO Zylon® + Black Dyneema

PBO / CDYN (C56_CDY)

NEW



DESCRIPTION AND USE:

The best choice to protect sophisticate cores in a super technical running rigging system, where high loads are the main stress for the rope.

PBO Zylon® + Black Technora®

PBO / BTEC (C74)

NEW



DESCRIPTION AND USE:

High loads and temperature don't scare this rope and it's a good solution for afterguys and runner sheets.

PBO Zylon® + Black Technora® + Black Dyneema®

PBO / BTEC / CDYN (C75_CDY)

NEW



DESCRIPTION AND USE:

Endurance is a must-have for the use on spinnaker/gennaker sheets, spinnaker/gennaker halyards, runner tails.

Black Technora® + Black Dyneema®

BTEC / CDYN (C35_CDY)

NEW



DESCRIPTION AND USE:

Ideal for high fatigue manoeuvres and repeated mechanical stress, in particular where the wear of the cover is steadily present e.g. jib sheets, tacklines and staysail sheets.

Black Technora® + Black Dyneema® + Poliestere

BTEC / CDYN / PET (C85_CDY)

NEW



DESCRIPTION AND USE:

Ideal for jib and gennaker sheets, halyard and control lines.

DYN 78 HPS SHIELD - BREAKING LOAD AND WEIGHT COMPARATIVE TABLE *

Ø	FOR ALL COVERS	PBO	PBO/CDYN	PBO/BTEC	PBO/BTEC/CDYN	BTEC/CDYN	BTEC/CDYN/PET
	NA58S	C56	C56_CDY	C74	C75_CDY	C35_CDY	C85_CDY
DIAM	B. L.	WEIGHT	WEIGHT	WEIGHT	WEIGHT	WEIGHT	WEIGHT
[mm]	[daN]	[g /m]	[g /m]	[g /m]	[g /m]	[g /m]	[g /m]
4	998	13,72	12,70	12,80	12,70	12,52	12,30
5	1.455	21,28	19,60	19,80	19,60	19,19	19,00
6	2.363	29,05	26,80	27,00	26,80	26,50	26,16
7	2.802	42,44	39,10	39,50	39,10	38,22	38,22
8	3.241	55,62	51,30	51,80	51,30	50,80	50,08
9	5.245	67,60	61,80	62,40	61,80	61,30	60,37
10	5.985	79,38	73,10	73,80	73,10	72,50	71,34
11	7.245	97,20	89,60	90,50	89,60	88,80	87,51
12	8.978	112,86	104,00	105,00	104,00	103,10	101,53
13	10.202	132,18	121,77	123,00	121,77	121,00	119,00
14	10.605	151,85	139,90	141,20	139,90	138,70	136,51
15	12.180	176,53	162,65	164,20	162,65	161,25	158,76
16	13.755	201,20	185,40	187,20	185,40	183,80	181,00
17	15.225	219,11	202,00	203,90	202,00	200,20	197,80
18	16.800	236,95	218,40	220,50	218,40	216,50	213,15
19	18.669	265,78	245,70	248,64	245,60	243,55	239,81
20	21.000	294,60	273,00	276,77	272,80	270,60	266,46

DYN 78 SHIELD - BREAKING LOAD AND WEIGHT COMPARATIVE TABLE *

Ø	FOR ALL COVERS	PBO	PBO/CDYN	PBO/BTEC	PBO/BTEC/CDYN	BTEC/CDYN	BTEC/CDYN/PET
	NA17S	C56	C56_CDY	C74	C75_CDY	C35_CDY	C85_CDY
DIAM	B. L.	WEIGHT	WEIGHT	WEIGHT	WEIGHT	WEIGHT	WEIGHT
[mm]	[daN]	[g /m]	[g /m]	[g /m]	[g /m]	[g /m]	[g /m]
4	735	13,72	12,70	12,80	12,30	12,52	12,30
5	998	21,38	19,70	19,90	19,30	19,29	19,30
6	1.785	29,05	26,80	27,00	26,17	26,50	26,17
7	2.730	41,93	39,00	39,10	37,80	38,25	37,70
8	2.940	54,65	50,40	50,90	49,20	49,90	49,20
9	4.305	65,92	60,80	61,40	59,33	60,20	59,30
10	5.744	77,11	71,10	71,80	69,38	70,40	69,38
11	6.405	93,94	86,60	87,44	84,50	85,75	84,50
12	6.890	110,70	102,00	103,00	99,57	101,10	99,57
13	8.505	130,15	120,10	121,15	117,10	118,90	117,00
14	9.608	149,58	137,80	139,20	134,55	136,60	134,55
15	11.550	168,72	155,45	157,00	151,80	154,10	151,80
16	12.705	187,81	173,00	174,70	168,95	171,50	168,95
17	14.312	213,26	181,30	183,10	177,10	180,00	177,00
18	15.960	226,23	189,50	191,40	185,02	187,90	185,02
19	17.535	239,20	221,14	223,78	221,00	219,20	215,83
20	18.743	265,14	245,70	249,10	245,52	243,54	239,82

Super Yacht line

AVAILABLE CORES

Dyneema® SK99

Treatments: HPS / PU

Dyneema® SK78

Treatments: HPS / PU

AVAILABLE COVERS

Black Technora®

Dyneema®

BTEC / DYN

Black Technora®

Dyneema®

Polyester

BTEC / DYN / PET

Black Technora®

Polyester

BTEC / PET

Kevlar®

Dyneema®

Polyester

KEV / DYN / PET

Cordura® + Polyester

CRD / PET

Polyester

PET

AVAILABLE TREATMENT



HALYARDS AND SHEETS, MADE BY THE MOST ADVANCED FIBRES AND TAPERED ON REQUEST, AND A SPECIFIC CAPTIVE WINCH LINE, CONSTITUTE THE BIG RANGE OF PRODUCTS

Captive Winch Rope

Thanks to the cooperation with leader companies in the production of Captive Winch and the supply to prestigious Super Yachts, Armare has improved and reached high performance levels also in this range of products. Thousands of meters provided to the most important companies specialized in the “rigging works” and well-known shipyards, prove, more than many words, the steady growth and the care of Armare in the research of new solutions, in order to solve problems linked to this specific use.

Captive Winch products preserve high breaking loads and low elongation thanks to the use of high modulus fibres.

Moreover, they hold the essential characteristics necessary to grant the good working of a Captive Winch System like flexibility, a steady shape, no sliding between core and cover, high abrasion resistance and excellent behaviour between sliding and grip on drums. The choice can be made among five different types of covers. Each one has diverse characteristics suitable for different types of winches and yachts they will be settled on (more information at page 40).

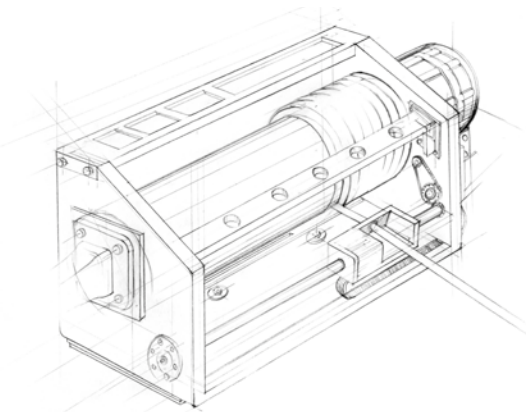

Rope with Captive treatment

The rope with Captive treatment is linear and compact; core and cover perfectly fit together.



Rope without Captive treatment

The rope without Captive Treatment could show a progressive “slack” that accumulates gradually and may cause damage to the cover.



Available Cores

Dyneema® SK99





Treatments: HPS / PU

Dyneema® SK99 delivers the highest tenacity available in a light weight polymer fiber. Indeed, compared to Dyneema® SK78, it shows a 20% increase on tenacity and a 35% higher modulus. Dyneema® SK99 appears thinner and lighter weight respect to ropes with the same diameter, but with a significant increase in strength, which entails an increase on performance and a better response of the boat. Other features: low water absorption, high UV resistance, minimal elongation and good flexibility.

Dyneema® SK78





Treatments: HPS / PU

The High Modulus fiber Dyneema® SK78, characterized by a remarkable stability under constant loads, provides the following features: low creep, elevated breaking load, low elongation, light weight, low level of water absorption, high resistance to UV rays and abrasion, great flexibility, high resistance to cutting. The ropes made with Dyneema® SK78 + HPS + PU are therefore destined to extreme performances, especially during highly demanding regattas when the permanent load is continuously present.

Available Covers

Black Technora® / Dyneema®

BTEC / DYN

The mixture of these fibres has been carefully studied to be fairly distributed in order to make them take advantage of their mutual characteristics, both in terms of durability and performance. Excellent results in order of smoothness, abrasion resistance and durability have been reached.

Black Technora® / Dyneema® / Polyester

BTEC / DYN / PET

This item is suitable for many different boats and uses because of its excellent resistance to abrasion and to repeated bending. Compared to TEC/DYN covers, it is easier to customize thanks to the presence of Polyester and it even becomes more recognizable in the distinction of the different manoeuvres.

Black Technora® / Polyester

BTEC / PET

It combines high level functional characteristics, with UV and abrasion resistance as well as a good grip. Thanks to the mixture among the Black Technora® and the different Polyester colours, the look is also winning.

Kevlar® / Dyneema® / Polyester

KEV / DYN / PET

It preserves similar characteristics as its sister-cover BTEC/DYN/PET, but thanks to the high point of fusion of Kevlar® it is more suitable for high speed manoeuvres and load, where the ropes reach high temperatures. It holds one of the best grips but a lower UV resistance in comparison to Black Technora®, which is composed by special pigments that protract his life, despite of exposure to UV rays.

Cordura® / Polyester

CRD / PET

This rope stands out for its lightness and perfect grip. It has been studied to obtain an excellent grip on stoppers and winches through the use of special anti-slip fibers.

Polyester

PET

It is the most used fiber on different types of boats thanks to its good resistance to UV rays and to abrasion and for its excellent durability to atmospheric agents. Moreover, it is easy to customize and ideal to diversify the different manoeuvres.

DYNEEMA® SK99 + HPS + PU

DYNEEMA® SK99 + HPS + PU - BREAKING LOAD AND WEIGHT COMPARATIVE TABLE

Ø	DYNEFORCE 99 SINGLE BRAID		FOR ALL COVERS	BTEC/ DYN	BTEC/ DYN/PET	BTEC/ PET	KEV/DYN /PET	CRD/ PET	PET
	NA20C00			NA20C35	NA20C85	NA20C86	NA20C78	NA20C24	NA20C71
DIAMETER	B. L.	WEIGHT	B. L.	WEIGHT	WEIGHT	WEIGHT	WEIGHT	WEIGHT	WEIGHT
[mm]	[daN]	[g /m]	[daN]	[g /m]	[g /m]	[g /m]	[g /m]	[g /m]	[g /m]
14	26.080	110,00	12.446	140,09	138,21	141,03	138,21	135,79	137,16
15	30.000	129,00	14.680	162,86	160,51	163,79	160,51	157,88	159,48
16	37.000	145,00	15.550	185,64	182,81	186,55	182,81	179,98	181,80
17	39.940	162,00	16.495	202,19	199,08	201,92	199,08	195,98	197,96
18	42.700	180,00	18.220	218,67	215,28	219,68	215,28	211,98	214,12
20	49.500	216,00	26.080	273,31	269,12	274,62	269,12	264,97	267,65
22	63.500	278,00	37.000	314,19	311,08	319,16	307,97	307,97	311,08
24	68.900	330,00	42.700	372,34	368,65	378,25	364,96	364,96	368,65
26	83.460	355,00	49.500	428,44	424,20	435,21	419,96	419,96	424,20
28	91.500	418,00	63.500	566,16	560,55	575,09	554,94	554,94	560,55
30	99.920	497,00	68.900	703,87	696,90	714,98	689,93	689,93	696,90
32	108.300	565,33	83.460	740,52	733,19	747,86	725,86	725,86	733,19
34	116.800	636,33	91.500	825,66	817,48	833,83	809,31	809,31	817,48
36	-	-	99.920	910,79	901,78	919,81	892,76	892,76	901,78
38	-	-	108.300	995,93	986,07	1.005,79	976,21	976,21	986,07
40	-	-	116.800	1.081,06	1.070,36	1.091,77	1.059,66	1.059,66	1.070,36

NOTE ABOUT BREAKING LOAD AND DIAMETERS The average values shown above are derived from tests taken at Armare laboratory, on properly spliced new ropes, and may change without notice. Other diameters available on request. The static load of the rope must not exceed 20% of breaking load shown in the table. Knots may affect the breaking load of the rope with reductions of up to 60%. The splicing increases the diameter of the rope of about 1.5 times. The use and exposure to weather conditions, depending from the kind of rope and the time of exposure, can reduce the breaking loads of the ropes.

DYNEFORCE 99 Single Braid PRODUCT CODE NA20C00



CONSTRUCTION 12 plait with Dyneema® SK99 impregnated with polyurethane coating and special heat treatment HPS.

USE Ideal for tackles, backstays, runners, baby stays, halyards on hydraulic cylinders, strops and loops; moreover for bindings where high breaking load, low elongation and minimal amount of space are required.

STANDARD DIAMETERS

From 14 to 34 mm

Other diameters on request

STRETCH AT 30% B. L. 1,70%

STRETCH AT B. L. 2,86%

COLOURS



White



Black



Silver Grey

SK99 - BTEC / DYN PRODUCT CODE NA20C35



COVER Black Technora® / Dyneema®

CORE 12 plait with Dyneema® SK99 impregnated with polyurethane coating and special heat treatment HPS.

USE Ideal for high fatigue manoeuvres and repeated mechanical stress, in particular where the wear of the cover is steadily present e.g. jib sheets, tacklines and staysail sheets.

STANDARD DIAMETERS

From 14 to 40 mm

Other diameters on request

STRETCH AT 30% B. L. 1,70%

STRETCH AT B. L. 2,86%

COLOURS Melange Natural Black Technora® / Dyneema®



BTEC / DYN

SK99 - BTEC / DYN / PET

PRODUCT CODE NA20C85



COVER Black Technora® / Dyneema® / Polyester

CORE 12 plait with Dyneema® SK99 impregnated with polyurethane coating and special heat treatment HPS.

USE It's simple to control and to release on winches. Ideal for jib and gennaker sheets, halyard and control lines.

STANDARD DIAMETERS

From 14 to 40 mm

Other diameters on request

STRETCH AT 30% B. L. 1,70%

STRETCH AT B. L. 2,86%

COLOURS Melange Black Technora® / Dyneema® / Polyester to choose from:



SK99 - BTEC / PET

PRODUCT CODE NA20C86



COVER Black Technora® / Polyester

CORE 12 plait with Dyneema® SK99 impregnated with polyurethane coating and special heat treatment HPS.

USE This rope is used on monotypes, oceanic boats and on Super Yachts as sheets and halyards with a good grip and high chafe resistance.

STANDARD DIAMETERS

From 14 to 40 mm

Other diameters on request

STRETCH AT 30% B. L. 1,70%

STRETCH AT B. L. 2,86%

COLOURS Melange Black Technora® / Polyester to choose from:



SK99 - KEV / DYN / PET

PRODUCT CODE NA20C78



COVER Kevlar® / Dyneema® / Polyester

CORE 12 plait with Dyneema® SK99 impregnated with polyurethane coating and special heat treatment HPS.

USE Ideal for manoeuvres of high fatigue and cyclical mechanical stress e.g. jib sheets, tacklines and staysail sheets.

STANDARD DIAMETERS

From 14 to 40 mm

Other diameters on request

STRETCH AT 30% B. L. 1,70%

STRETCH AT B. L. 2,86%

COLOURS Melange Kevlar® / Dyneema® / Polyester to choose from:



SK99 - CRD / PET

PRODUCT CODE NA20C24



COVER Cordura® / Polyester

CORE 12 plait with Dyneema® SK99 impregnated with polyurethane coating and special heat treatment HPS.

USE Excellent grip on stopper and winch. It can be chosen either as halyard, as sheet and for all control lines thanks to its soft and grip touch.

STANDARD DIAMETERS

From 14 to 40 mm

Other diameters on request

STRETCH AT 30% B. L. 1,70%

STRETCH AT B. L. 2,86%

COLOURS Melange Cordura® / Polyester to choose from:



SK99 - PET

PRODUCT CODE NA20C71



COVER Polyester

CORE 12 plait with Dyneema® SK99 impregnated with polyurethane coating and special heat treatment HPS.

USE Indicated for multiple uses: sheets, halyards and general running rigging.

STANDARD DIAMETERS

From 14 to 40 mm

Other diameters on request

STRETCH AT 30% B. L. 1,70%

STRETCH AT B. L. 2,86%

COLOURS



DYNEEMA® SK78 + HPS + PU

DYNEEMA® SK78 + HPS + PU - BREAKING LOAD AND WEIGHT COMPARATIVE TABLE

Ø	DYNEFORCE 78 SINGLE BRAID		FOR ALL COVERS	BTEC/ DYN	BTEC/ DYN/PET	BTEC/ PET	KEV/ DYN/PET	CRD/ PET	PET
	NA58C00								
DIAMETER	B. L.	WEIGHT	B. L.	WEIGHT	WEIGHT	WEIGHT	WEIGHT	WEIGHT	WEIGHT
[mm]	[daN]	[g /m]	[daN]	[g /m]	[g /m]	[g /m]	[g /m]	[g /m]	[g /m]
14	20.000	128,00	10.100	138,70	136,51	139,30	136,51	134,44	148,40
15	23.000	145,00	11.600	161,25	158,76	162,00	158,76	156,32	164,20
16	26.300	160,00	13.100	183,80	181,00	184,70	181,00	178,20	180,00
17	29.000	180,00	14.500	200,15	197,08	201,10	197,08	194,05	196,00
18	31.400	200,00	16.000	216,50	213,15	217,50	213,15	209,90	212,00
20	37.000	250,00	20.000	270,60	266,46	271,90	266,46	262,35	265,00
22	44.000	300,00	26.300	311,08	299,00	316,00	299,00	304,92	308,00
24	50.500	350,00	31.400	368,65	374,50	374,50	374,50	361,35	365,00
26	56.200	380,00	34.300	424,20	430,90	430,90	430,90	415,80	420,00
28	65.000	430,00	44.000	560,55	569,40	569,40	569,40	549,45	556,00
30	72.900	475,00	50.500	696,90	707,90	707,90	707,90	683,10	690,00
32	80.000	526,00	56.200	833,25	948,75	841,50	948,75	816,75	825,00
34	87.000	578,00	65.000	937,28	997,90	946,56	928,00	918,72	928,00
36	-	-	72.900	1.057,47	1.047,00	1.067,94	1.047,00	1.036,53	1.047,00
38	-	-	80.000	1.177,66	1.166,00	1.189,32	1.166,00	1.154,34	1.166,00
40	-	-	87.000	1.297,85	1.285,00	1.310,70	1.285,00	1.272,15	1.285,00

NOTE ABOUT BREAKING LOAD AND DIAMETERS The average values shown above are derived from tests taken at Armare laboratory, on properly spliced new ropes, and may change without notice. Other diameters available on request. The static load of the rope must not exceed 20% of breaking load shown in the table. Knots may affect the breaking load of the rope with reductions of up to 60%. The splicing increases the diameter of the rope of about 1.5 times. The use and exposure to weather conditions, depending from the kind of rope and the time of exposure, can reduce the breaking loads of the ropes.

DYNEFORCE 78 Single Braid PRODUCT CODE NA58C00



CONSTRUCTION 12 plait with Dyneema® SK78 impregnated with polyurethane coating and special heat treatment HPS.

USE Ideal for tackles, backstays, runners, baby stays, control lines, strops and loops; moreover for lashings where a good breaking load and a low elongation are required.

STANDARD DIAMETERS

From 14 to 34 mm
Other diameters on request

STRETCH AT 30% B. L. 2,16%

STRETCH AT B. L. 3,20%

COLOURS



SK78 - BTEC / DYN PRODUCT CODE NA58C35



COVER Black Technora® / Dyneema®

CORE 12 plait with Dyneema® SK78 impregnated with polyurethane coating and special heat treatment HPS.

USE Ideal for high fatigue manoeuvres and repeated mechanical stress, in particular where the wear of the cover is steadily present e.g. jib sheets, tacklines and staysail sheets.

STANDARD DIAMETERS

From 14 to 40 mm
Other diameters on request

STRETCH AT 30% B. L. 2,16%

STRETCH AT B. L. 3,20%

COLOURS Melange Natural Black Technora® / Dyneema®.



BTEC / DYN

SK78 - BTEC / DYN / PET

PRODUCT CODE NA58C85



COVER Black Technora® / Dyneema® / Polyester

CORE 12 plait with Dyneema® SK78 impregnated with polyurethane coating and special heat treatment HPS.

USE It's simple to control and to release on winches. Ideal for jib and gennaker sheets, halyard and control lines.

STANDARD DIAMETERS

From 14 to 40 mm
Other diameters on request

STRETCH AT 30% B. L. 2,16%

STRETCH AT B. L. 3,20%

COLOURS Melange Black Technora® / Dyneema® / Polyester to choose from:

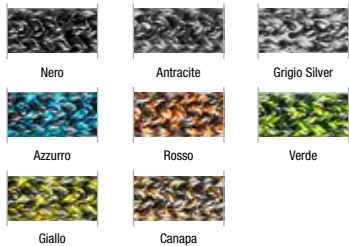

SK78 - BTEC / PET

PRODUCT CODE NA58C86



COVER Black Technora® / Polyester

CORE 12 plait with Dyneema® SK78 impregnated with polyurethane coating and special heat treatment HPS.

USE This rope is used on monotypes, oceanic boats and on Super Yachts as sheets and halyards with a good grip and high chafe resistance.

STANDARD DIAMETERS

From 14 to 40 mm
Other diameters on request

STRETCH AT 30% B. L. 2,16%

STRETCH AT B. L. 3,20%

COLOURS Melange Black Technora® / Polyester to choose from:



SK78 - KEV / DYN / PET

PRODUCT CODE NA58C78



COVER Kevlar® / Dyneema® / Polyester

CORE 12 plait with Dyneema® SK78 impregnated with polyurethane coating and special heat treatment HPS.

USE Ideal for manoeuvres of high fatigue and cyclical mechanical stress e.g. jib sheets, tacklines and staysail sheets.

STANDARD DIAMETERS

From 14 to 40 mm
Other diameters on request

STRETCH AT 30% B. L. 2,16%

STRETCH AT B. L. 3,20%

COLOURS Melange Kevlar® / Dyneema® / Polyester to choose from:



SK78 - CRD / PET

PRODUCT CODE NA58C24



COVER Cordura® / Polyester

CORE 12 plait with Dyneema® SK78 impregnated with polyurethane coating and special heat treatment HPS.

USE Excellent grip on stopper and winch. It can be chosen either as halyard, as sheet and for all control lines thanks to its soft and grip touch.

STANDARD DIAMETERS

From 14 to 40 mm
Other diameters on request

STRETCH AT 30% B. L. 2,16%

STRETCH AT B. L. 3,20%

COLOURS Melange Cordura® / Polyester to choose from:

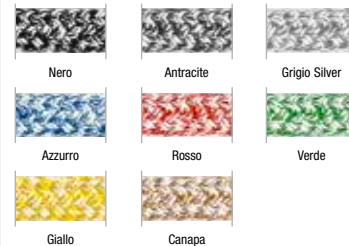

SK78 - PET

PRODUCT CODE NA58C71



COVER Polyester

CORE 12 plait with Dyneema® SK78 impregnated with polyurethane coating and special heat treatment HPS.

USE Indicated for multiple uses: sheets, halyards and general running rigging.

STANDARD DIAMETERS

From 14 to 40 mm
Other diameters on request

STRETCH AT 30% B. L. 2,16%

STRETCH AT B. L. 3,20%

COLOURS



DYNEEMA® SK78 + HPS + PU + CAPTIVE



DYNEEMA® SK78 + HPS + PU + Captive Treatment - BREAKING LOAD AND WEIGHT COMPARATIVE TABLE

Ø	FOR ALL COVERS	BTEC/ DYN	BTEC/ DYN/PET	BTEC/ PET	GRD/ PET	PET
		NA58C35_CW	NA58C85_CW	NA58C86_CW	NA58C24_CW	NA58C71_CW
DIAMETER	B. L.	WEIGHT	WEIGHT	WEIGHT	WEIGHT	WEIGHT
[mm]	[daN]	[g /m]	[g /m]	[g /m]	[g /m]	[g /m]
14	10.100	138,70	136,51	139,30	134,44	148,40
15	11.600	161,25	158,76	162,00	156,32	164,20
16	13.100	183,80	181,00	184,70	178,20	180,00
17	14.500	200,15	197,08	201,10	194,05	196,00
18	16.000	216,50	213,15	217,50	209,90	212,00
20	20.000	270,60	266,46	271,90	262,35	265,00
22	26.300	311,08	299,00	316,00	304,92	308,00
24	31.400	368,65	374,50	374,50	361,35	365,00
26	34.300	424,20	430,90	430,90	415,80	420,00
28	44.000	560,55	569,40	569,40	549,45	556,00
30	50.500	696,90	707,90	707,90	683,10	690,00
32	56.200	833,25	948,75	841,50	816,75	825,00
34	65.000	937,28	997,90	946,56	918,72	928,00
36	72.900	-	-	-	-	-
38	80.000	-	-	-	-	-
40	87.000	-	-	-	-	-



Note: Intermediate diameters on request

NOTE ABOUT BREAKING LOAD AND DIAMETERS The average values shown above are derived from tests taken at Armare laboratory, on properly spliced new ropes, and may change without notice. Other diameters available on request. The static load of the rope must not exceed 20% of breaking load shown in the table. Knots may affect the breaking load of the rope with reductions of up to 60%. The splicing increases the diameter of the rope of about 1.5 times. The use and exposure to weather conditions, depending from the kind of rope and the time of exposure, can reduce the breaking loads of the ropes.

SK78 - BTEC / DYN

PRODUCT CODE NA58C35_CW



COVER Black Technora® / Dyneema® + Captive treatment

CORE 12 plait with Dyneema® SK78 impregnated with polyurethane coating and special heat treatment HPS.

STANDARD DIAMETERS

From 14 to 40 mm
Other diameters on request

STRETCH AT 30% B. L. 2,16%
STRETCH AT B. L. 3,20%

COLOURS Melange Natural Black Technora® / Dyneema®.



BTEC / DYN

SK78 - BTEC / DYN / PET

PRODUCT CODE NA58C85_CW

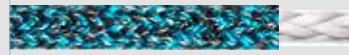

COVER Black Technora® / Dyneema® / Polyester + Captive treatment

CORE 12 plait with Dyneema® SK78 impregnated with polyurethane coating and special heat treatment HPS.

STANDARD DIAMETERS

From 14 to 40 mm
Other diameters on request

STRETCH AT 30% B. L. 2,16%
STRETCH AT B. L. 3,20%

COLOURS Melange Black Technora® / Dyneema® / Polyester to choose from:



Black Anthracite Silver Grey



Light Blue Red Green



Yellow Hemp

SK78 - BTEC / PET

PRODUCT CODE NA58C86_CW

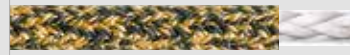

COVER Black Technora® / Polyester + Captive treatment

CORE 12 plait with Dyneema® SK78 impregnated with polyurethane coating and special heat treatment HPS.

STANDARD DIAMETERS

From 14 to 40 mm
Other diameters on request

STRETCH AT 30% B. L. 2,16%
STRETCH AT B. L. 3,20%

COLOURS Melange Black Technora® / Polyester to choose from:



Black Anthracite Silver Grey

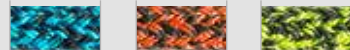

Light Blue Red Green



Yellow Hemp

SK78 - CRD / PET

PRODUCT CODE NA58C24_CW



COVER Cordura® / Polyester + Captive treatment

CORE 12 plait with Dyneema® SK78 impregnated with polyurethane coating and special heat treatment HPS.

STANDARD DIAMETERS

From 14 to 40 mm
Other diameters on request

STRETCH AT 30% B. L. 2,16%
STRETCH AT B. L. 3,20%

COLOURS Melange Cordura® / Polyester to choose from:



Black Anthracite Silver Grey



Light Blue Red Green



Yellow Hemp

SK78 - PET

PRODUCT CODE NA58C71_CW



COVER Polyester + Captive treatment

CORE 12 plait with Dyneema® SK78 impregnated with polyurethane coating and special heat treatment HPS.

STANDARD DIAMETERS

From 14 to 40 mm
Other diameters on request

STRETCH AT 30% B. L. 2,16%
STRETCH AT B. L. 3,20%

COLOURS

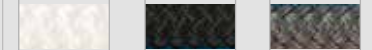

White Black Anthracite



Silver Grey Red Blue Navy



Light Blue Yellow Hemp

Super Yacht mooring solutions

INCREASINGLY MAJESTIC SUPER YACHTS REQUIRE MORE AND MORE PERFORMING MOORING LINES. TO IMPROVE THE WORKING CONDITIONS OF THE CREW AS WELL AS THEIR PERFORMANCE, SUPER YACHTS MUST ADOPT MOORING LINES THAT ENSURE VERY HIGH BREAKING LOADS WITHOUT INCREASING THE DIAMETER OF THE ROPES AND AS A CONSEQUENCE THEIR WEIGHT.

Mooring of Super Yachts: how to make it safer and easier

Professionals are aware of the increase of accidents during the docking, as handling ropes having big diameter, especially when they are wet and heavy, slows down the mooring process, increases the risk of accidents and puts the crew in danger. To improve the specific working conditions of the crew, Armare managed to design mooring ropes that ensure high breaking loads without increasing diameters and weights: **Storm Line Plus**, the floating **Secur Line**, **Square Line PP** and **Novus Line** are joining the collection of Mooring Lines.



Storm Line Plus



Secur Line
(floating Dyneema®)



Square Line PP
(floating Polypropylene)



Novus Line

Polyester Stretcher Loop

NEW

Mooring ropes made of technical fibers, characterized by high breaking loads and low elongation, require the use of “shock absorbers” able to cushion tears and frequent mechanical stress Super Yacht lines are exposed to.

“Stretcher Loops” guarantee a safe and more comfortable mooring of the boat to the crew and the guests, particularly in heavy winds, high waves and strong undertow.

Those loops are custom-made in accordance with the breaking load of the ropes which they will be settled on. Due to the fact that the core of the ropes made of Dyneema® or HMPE fibers has a very high breaking load but a reduced elongation, like our Secure Line and in particular our Storm Line Plus, we always advise to equip them with a proper “Stretcher Loop” made of Polyester.



Splicing and protections

The great experience on Super Yacht mooring lines has taken Armare to a leading position on the market. Our strength is the possibility to customize every single detail of the rope, e.g. diameters, colours, lengths, finishing. All the splicing and protections are available on the complete range of mooring lines.

Available manufactures:

- Splicing on stainless-steel thimble
- Handmade finishing with Cordura® heavy fabric
- Handmade leather finishing
- Splicing with loop of every size
- Possibility of embroideries on every type of protection

Types of splicing and protections



Stainless-steel thimble without protection



Loop without protection



Loop with leather protection

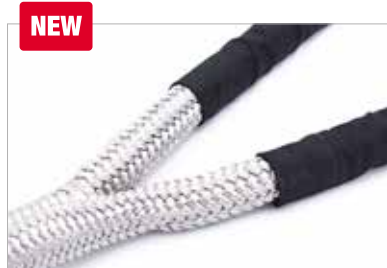

Spliced loop with Cordura® fabric heavy protection

Available standard colours of the ropes



White

Black

Blue Navy

Available special colours of the ropes



Silver Grey

Hemp

Red



Bordeaux

English green

Available leathers protections



Natural

Brown

Black

Cordura® heavy fabric



Black

All the finishes are available on the complete range of mooring lines.



SUPER YACHT MOORING ROPES BREAKING LOAD AND WEIGHT COMPARATIVE TABLE

Ø	STORM LINE PLUS		NOVUS LINE		SECUR LINE		SQUARE LINE PP		STORM LINE		ROUND LINE		SQUARE LINE	
	NA90_SLP		NA17C63		N037		NA43		N020		NA40		NA41	
	B. L.	WEIGHT	B. L.	WEIGHT	B. L.	WEIGHT	B. L.	WEIGHT	B. L.	WEIGHT	B. L.	WEIGHT	B. L.	WEIGHT
[mm]	[daN]	[g /m]	[daN]	[g /m]	[daN]	[g /m]	[daN]	[g /m]	[daN]	[g /m]	[daN]	[g /m]	[daN]	[g /m]
3	-	-	-	-	-	-	-	-	-	-	-	-	-	-
4	-	-	-	-	-	-	-	-	-	-	-	-	-	-
5	-	-	-	-	-	-	-	-	-	-	-	-	-	-
6	-	-	-	-	-	-	-	-	-	-	-	-	-	-
7	-	-	-	-	-	-	-	-	-	-	-	-	-	-
8	-	-	-	-	-	-	-	-	2.000	46,00	-	-	-	-
9	-	-	-	-	-	-	-	-	-	-	-	-	-	-
10	-	-	-	-	10.000	63,00	-	-	2.650	68,00	-	-	1.600	71,00
11	-	-	-	-	-	-	-	-	-	-	-	-	-	-
12	-	-	-	-	12.500	82,00	1.560	56,00	3.500	97,00	-	-	2.100	92,00
14	-	-	6.000	105,00	15.000	100,00	2.000	78,00	4.200	134,00	-	-	2.900	128,00
16	11.500	163,00	7.000	120,00	18.000	130,00	2.500	92,00	4.900	144,00	4.160	170,00	3.500	152,00
18	-	-	9.000	135,00	-	180,00	3.200	115,00	5.400	188,00	5.018	195,00	4.100	170,00
20	18.200	239,00	10.500	182,00	23.000	220,00	4.000	160,00	8.500	288,00	5.460	240,00	4.500	225,00
22	24.400	305,00	12.700	244,00	-	-	5.000	178,00	11.600	365,00	6.045	305,00	5.000	255,00
24	30.000	366,00	14.500	290,00	28.000	300,00	5.500	214,00	13.500	441,00	6.890	350,00	5.700	290,00
26	37.000	425,00	15.800	330,00	-	-	-	-	14.600	510,00	8.099	421,00	6.500	360,00
28	45.000	477,00	17.000	350,00	34.000	340,00	7.000	280,00	18.500	575,00	10.465	550,00	8.400	380,00
30	52.000	608,00	19.400	370,00	-	-	-	-	20.000	640,00	11.648	630,00	9.650	470,00
32	61.000	740,00	20.800	390,00	39.000	400,00	9.500	365,00	23.600	890,00	12.350	710,00	10.870	560,00
34	70.000	838,00	-	-	-	-	-	-	-	-	-	-	-	-
36	79.000	937,00	22.000	505,00	45.000	500,00	13.000	471,00	25.500	1.130,00	15.600	850,00	13.700	640,00
38	88.000	999,00	-	-	-	-	-	-	-	-	-	-	-	-
40	99.500	1.062,00	25.300	568,00	50.000	560,00	17.000	525,00	31.000	1.280,00	17.500	1.160,00	15.580	830,00
44	-	-	-	-	55.000	626,00	19.000	585,00	36.000	1.470,00	20.000	1.450,00	19.400	1.050,00
48	-	-	-	-	60.000	680,00	22.500	645,00	40.800	1.760,00	-	-	23.300	1.200,00
52	-	-	-	-	-	-	24.000	705,00	49.900	2.050,00	-	-	28.100	1.320,00

NOTE ABOUT BREAKING LOAD AND DIAMETERS The average values shown above are derived from tests taken at Armare laboratory, on properly spliced new ropes, and may change without notice. Other diameters available on request. The static load of the rope must not exceed 20% of breaking load shown in the table. Knots may affect the breaking load of the rope with reductions of up to 60%. The splicing increases the diameter of the rope of about 1.5 times. The use and exposure to weather conditions, depending from the kind of rope and the time of exposure, can reduce the breaking loads of the ropes.

Storm Line Plus

PRODUCT CODE NA90_SLP



100% SK78

CONSTRUCTION

Balanced twist Dyneema® braided core, Polyester cover.

FEATURES AND USE

It brings a significant improvement to the lives of the crew, ensuring very high breaking load and small diameters, extreme safety and low water absorption. Furthermore, thanks to the core in Dyneema®, the weight is halved if compared to ropes with equal load in Polyester/ Nylon. The choice of Storm Line Plus for the mooring of your boat provides an economic benefit over time, thanks to the extraordinary durability.

STANDARD DIAMETERS

From 16 to 40 mm

STANDARD COLOURS



Novus Line

PRODUCT CODE NA17C63

NEW



100% SK78

PU COATED TREATMENT

FLOATING

CONSTRUCTION

Double Braid - 100% Dyneema® SK78 core, 100% H.T. Polypropylene cover.

FEATURES AND USE

The latest new rope concept for floatable moorings and towing lines. Novus Line is a new generation rope made with a Dyneema® SK78 braiding core, which assures the 100% of the load and protected and covered by a 12 strands braid in H.T. Polypropylene with UV treatment. The result is an incredible floating rope extremely flexible and easily maneuverable, with high breaking strength, light weight, low water absorption. It assures a good protection from accidental cutting and is spliceable with a right technique.

STANDARD DIAMETERS

From 14 to 40 mm

STANDARD COLOURS

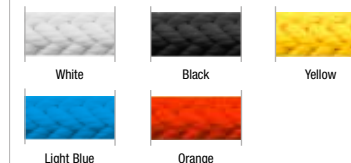

Secur Line

PRODUCT CODE N037



CONSTRUCTION

Balanced twist 8 strand braid made with 100% Dyneema® SK78 and PU Coating.

FEATURES AND USE

Ideal for emergency anchoring and long mooring from boat to land and as towing line. Made of 100% Dyneema® SK78 it assures high breaking load, lightness, low elongation, almost zero water absorption, high visibility of the rope and high resistance to abrasion and cut.

STANDARD DIAMETERS

From 10 to 48 mm

STANDARD COLOURS



Silver Grey Hemp Yellow

Square Line PP

PRODUCT CODE NA43



CONSTRUCTION

8 strand braid in H.T. Polypropylene with UV treatment.

FEATURES AND USE

Multi-use floating line, for long moorings and towing.

STANDARD DIAMETERS

From 12 to 52 mm

STANDARD COLOURS



White Black Yellow



Light Blue Arancio

Storm Line

PRODUCT CODE N020



CONSTRUCTION

Balanced twisted Polyester braided core, Polyester cover.

FEATURES AND USE

Ideal for Super Yachts but also for emergency or long moorings of small and medium sized boats.

STANDARD DIAMETERS

From 8 to 52 mm

STANDARD COLOURS



White Black Blue Navy

SPECIAL COLOURS



Silver Grey Hemp Red



Bordeaux English Green

Round Line

PRODUCT CODE NA40



CONSTRUCTION

12 strand braid in Polyester.

FEATURES AND USE

For the mooring of small boats to Super Yachts. Always smooth, even after prolonged use. Easy to splice.

STANDARD DIAMETERS

From 16 to 44 mm

STANDARD COLOURS



White Black Blue Navy

SPECIAL COLOURS



Silver Grey Hemp Red



Bordeaux English Green

Square Line

PRODUCT CODE NA41



CONSTRUCTION

8 strand braid in Polyester.

FEATURES AND USE

Commonly used for the mooring of all types of boats up to Super Yachts, anchoring as well as temporary and long moorings of medium and small boats.

STANDARD DIAMETERS

From 10 to 52 mm

STANDARD COLOURS



White Black Blue Navy

SPECIAL COLOURS



Silver Grey Hemp Red



Bordeaux English Green

Racing line

ARMARE RACING LINE PRODUCTS ARE SPECIFICALLY DEDICATED TO PROFESSIONAL RACERS AND HAVE BEEN DESIGNED, MANUFACTURED AND TESTED ON HIGH PERFORMANCE BOATS, TO MEET THE SPECIFIC NEEDS OF THOSE WHO LIVE AND/OR WORK AT SEA.

AVAILABLE CORES

Dyneema® SK99

Treatments: HPS / PU

Dyneema® SK78

Treatments: HPS / PU



AVAILABLE COVERS

PBO-Zylon®

Dyneema®

PBO / DYN

PBO - Zylon®

Black Technora®

or Gold Technora®

Dyneema®

PBO / BTEC or GTEC / DYN

Black Technora®

or Gold Technora®

Dyneema®

BTEC or GTEC / DYN

Black Technora®

or Gold Technora®

Dyneema®

Polyester

BTEC or GTEC / DYN / PET

Kevlar®

Dyneema®

KEV / DYN

Kevlar®

Dyneema®

Polyester

KEV / DYN / PET

Available Covers

PBO / Dyneema®

PBO / DYN

Thanks to the presence of PBO®, this cover has a high resistance to abrasion. The right mix with Dyneema® fibre transfers a good fluidity to the ropes when released on winch under load. Tests on racing boats have demonstrated the amazing durability to high frequency movements of the cover.

USE High load and temperature don't scare this cover. It is a good solution for afterguys and genoa sheets.

NEW

Black Technora® o Gold Technora® / Dyneema® / Polyester

BTEC or GTEC / DYN / PET

This item is suitable for many different boats and uses because of its excellent resistance to abrasion and to repeated bending. Compared to TEC/DYN covers, it is easier to customize thanks to the presence of Polyester and it even becomes more recognizable in the distinction of the different manoeuvres.

USE It's simple to control and to release on winches. Ideal for jib and gennaker sheets as well as for halyard and control lines.

NEW

PBO - Zylon® / Black Technora® o Gold Technora® / Dyneema®

PBO / BTEC or GTEC / DYN

This cover is the ideal choice for running rigging subjected to high loads or high temperatures. Moreover, it is suitable for all those manoeuvres where very fast recoveries are necessary as it avoids the melt of the fibers and damages that affect the life of the cover. The mixture of three different high-performance fibers guarantees a remarkable durability and smoothness as well as an excellent resistance to abrasion and heat, thanks to the high melting point of the basic fibers.

USE For the use on spinnaker/gennaker sheets, spinnaker/gennaker halyards, runner tails.

Kevlar® / Dyneema®

KEV / DYN

The combination in due proportions of Kevlar® and Dyneema® turns this cover into a first-class rope. It's a good alternative to PBO/DYN covers as soon as slightly lower loads but high repetition cycles on running rigging are required. Tests made on board of the top of the class racing boats during hard sessions of match races confirmed that those two fibres work in symbiosis and that their characteristics compensate one another.

USE This cover is used on One Design jib sheets and high-load tackles whenever the repetition of cycles on running rigging is high.

NEW

Black Technora® o Gold Technora® / Dyneema®

BTEC or GTEC / DYN

The mixture of these fibres has been carefully studied to be fairly distributed in order to make them take advantage of their mutual characteristics, both in terms of durability and performance. Excellent results in order of smoothness, abrasion resistance and durability have been reached.

USE Ideal for high fatigue manoeuvres and repeated mechanical stress, in particular where the wear of the cover is steadily present e.g. jib sheets, tacklines and staysail sheets.

Kevlar® / Dyneema® / Polyester

KEV / DYN / PET

It preserves similar characteristics as its sister-cover BTEC/DYN/PET, but thanks to the high point of fusion of Kevlar® it is more suitable for high speed manoeuvres and load. It holds one of the best grips but a lower UV resistance in comparison to Black Technora®, which is composed by special pigments that protract the life of the rope, despite of the exposure to UV rays.

USE Ideal for manoeuvres of high fatigue and cyclical mechanical stress e.g. jib sheets, tacklines and staysail sheets.

Racing line

Armare Racing Line products are made with two technical fibers that can be eventually completed with different choices of protective covers. The table summarises the main features of the fibers used for the construction of internal cores.

FIBER CHARACTERISTICS

FIBER		Dyneema® SK99	Dyneema® SK78
TENACITY	[cN/dTex]	42,50	35,10
MODULUS	[cN/dTex]	1.590	1.160
CREEP	[-]	Very Good	Very Good
SPECIFIC GRAVITY	[Kg/dm³]	0,975	0,975
MELTING TEMP	[°C]	147	147

Available Cores

Dyneema® SK99



Treatments: HPS / PU

Dyneema® SK99 delivers the highest tenacity available in a light weight polymer fiber. Indeed, compared to Dyneema® SK78, it shows a 20% increase on tenacity and a 35% higher modulus. Dyneema® SK99 appears thinner and lighter compared to ropes with the same diameter, but with a significant increase in strength, which entails an increase on performance and a better response of the boat. Other features: low water absorption, high UV resistance, minimal elongation and good flexibility.

Dyneema® SK78



Treatments: HPS / PU

The High Modulus fiber Dyneema® SK78, characterized by a remarkable stability under constant loads, provides the following features: low creep, elevated breaking load, low elongation, light weight, low level of water absorption, high resistance to UV rays and abrasion, great flexibility, high resistance to cutting. The ropes made with Dyneema® SK78 + HPS + PU are therefore destined to extreme performances, especially during highly demanding regattas when the permanent load is continuously present.



DYNEFORCE 99 Single Braid

CODICE PRODOTTO NA20C00



CONSTRUCTION 12 plait with Dyneema® SK99 impregnated with polyurethane coating and special heat treatment HPS.

USE Ideal for tackles, backstays, runners, baby stays, halyards on hydraulic cylinders, strops and loops; moreover for bindings where high breaking load, low elongation and minimal amount of space are required.

STANDARD DIAMETERS

From 1 to 30 mm.

Other diameters on request.

STRETCH AT 30% B. L. 1,70%

STRETCH AT B. L. 2,86%

COLOURS

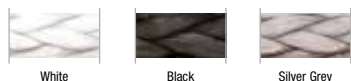

White

Black

Silver Grey

DYNEFORCE 99 SINGLE BRAID		
NA20C00		
DIAM	B. L.	WEIGHT
[mm]	[daN]	[g /m]
1	199	0,81
1,5	450	1,81
2	715	2,41
2,5	1.050	3,61
3	1.444	6,02
3,5	2.200	9,63
4	2.800	11,20
5	4.282	18,05
6	6.200	22,86
7	8.080	27,50
8	9.836	38,80
9	12.446	48,13
10	14.680	58,80
11	16.495	62,00
12	18.220	77,00
13	22.177	95,22
14	26.080	110,00
15	30.000	129,00
16	37.000	145,00
17	39.940	162,00
18	42.700	180,00
20	49.500	216,00

DYNEFORCE 78 Single Braid

CODICE PRODOTTO NA58C00



CONSTRUCTION 12 plait with Dyneema® SK78 impregnated with polyurethane coating and special heat treatment HPS.

USE Ideal for tackles, backstays, runners, baby stays, control lines, strops and loops; moreover for lashings where a good breaking load and a low elongation are required.

STANDARD DIAMETERS

From 1,5 to 30 mm.

Other diameters on request.

STRETCH AT 30% B. L. 2,16%

STRETCH AT B. L. 3,20%

COLOURS

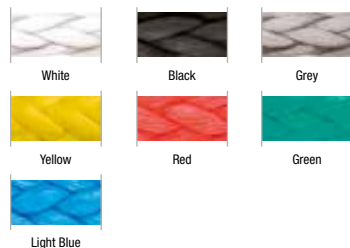

White

Black

Grey

Yellow

Red

Green

Light Blue

DYNEFORCE 78 SINGLE BRAID		
NA58C00		
DIAM	B. L.	WEIGHT
[mm]	[daN]	[g /m]
1	-	-
1,5	708	3,40
2	950	4,50
2,5	1.155	5,70
3	1.386	6,80
3,5	1.642	8,20
4	2.250	10,10
5	3.087	15,30
6	4.995	24,00
7	6.400	31,10
8	7.400	38,20
9	9.716	51,10
10	11.600	60,00
11	13.100	77,00
12	16.000	94,00
13	17.780	110,00
14	20.000	128,00
15	23.000	145,00
16	26.300	160,00
17	29.000	180,00
18	31.400	200,00
20	37.000	250,00



DYN - PBO / DYN
PRODUCT CODE C65



COVER PBO® / Dyneema®.

DYN SK99 HPS + PU			DYN SK78 HPS + PU		
NA20C65			NA58C65		
DIAM	B. L.	WEIGHT	DIAM	B. L.	WEIGHT
[mm]	[daN]	[g /m]	[mm]	[daN]	[g /m]
1	-	-	1	-	-
1,5	-	-	1,5	-	-
2	199	4,99	2	243	4,84
2,5	450	6,14	2,5	337	5,87
3	615	8,11	3	500	7,73
3,5	960	9,57	3,5	708	9,48
4	1.444	12,83	4	950	12,70
5	2.200	19,80	5	1.386	19,60
6	2.800	27,07	6	2.250	26,80
7	3.500	39,49	7	2.669	39,10
8	4.282	51,81	8	3.087	51,30
9	6.200	62,42	9	4.995	61,80
10	7.150	73,83	10	5.700	73,10
11	8.950	90,50	11	6.900	89,60
12	9.836	105,04	12	8.550	104,00
13	10.200	123,17	13	9.716	121,80
14	12.446	141,30	14	10.100	139,90
15	14.680	164,28	15	11.600	162,65
16	15.550	187,25	16	13.100	185,40
17	16.495	203,95	17	14.500	202,00
18	18.220	220,58	18	16.000	218,40
20	26.080	275,73	20	20.000	273,00

DYN - PBO / BTEC or GTEC / DYN
PRODUCT CODE C75 - C76

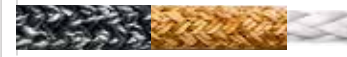

COVER PBO® / Black Technora®
 or Gold Technora® / Dyneema®.

DYN SK99 HPS + PU			DYN SK78 HPS + PU		
NA20C75 - C76			NA58C75 - C76		
DIAM	B. L.	WEIGHT	DIAM	B. L.	WEIGHT
[mm]	[daN]	[g /m]	[mm]	[daN]	[g /m]
1	-	-	1	-	-
1,5	-	-	1,5	-	-
2	-	-	2	-	-
2,5	-	-	2,5	-	-
3	615	7,88	3	500	7,73
3,5	960	9,29	3,5	708	9,48
4	1.444	12,42	4	950	12,70
5	2.200	19,19	5	1.386	19,60
6	2.800	26,23	6	2.250	26,80
7	3.500	38,60	7	2.669	39,10
8	4.282	50,58	8	3.087	51,30
9	6.200	60,97	9	4.995	61,80
10	7.150	72,05	10	5.700	73,10
11	8.950	88,39	11	6.900	89,60
12	9.836	102,55	12	8.550	104,00
13	10.200	120,38	13	9.716	121,80
14	12.446	138,21	14	10.100	139,90
15	14.680	160,51	15	11.600	162,65
16	15.550	182,81	16	13.100	185,40
17	16.495	199,08	17	14.500	202,00
18	18.220	215,28	18	16.000	218,40
20	26.080	269,12	20	20.000	273,00

DYN - BTEC or GTEC / DYN
PRODUCT CODE C35 - C72



COVER Black Technora®
 or Gold Technora® / Dyneema®.

DYN SK99 HPS + PU			DYN SK78 HPS + PU		
NA20C35 - C72			NA58C35 - C72		
DIAM	B. L.	WEIGHT	DIAM	B. L.	WEIGHT
[mm]	[daN]	[g /m]	[mm]	[daN]	[g /m]
1	-	-	1	-	-
1,5	-	-	1,5	-	-
2	199	4,90	2	243	4,75
2,5	450	6,02	2,5	337	5,76
3	615	7,96	3	500	7,58
3,5	960	9,38	3,5	708	9,29
4	1.444	12,55	4	950	12,52
5	2.200	19,38	5	1.386	19,19
6	2.800	26,77	6	2.250	26,50
7	3.500	39,19	7	2.669	38,80
8	4.282	51,31	8	3.087	50,80
9	6.200	61,91	9	4.995	61,30
10	7.150	73,23	10	5.700	72,50
11	8.950	89,69	11	6.900	88,80
12	9.836	104,13	12	8.550	103,10
13	10.200	122,11	13	9.716	121,00
14	12.446	140,09	14	10.100	138,70
15	14.680	162,86	15	11.600	161,25
16	15.550	185,64	16	13.100	183,80
17	16.495	202,19	17	14.500	200,15
18	18.220	218,67	18	16.000	216,50
20	26.080	273,31	20	20.000	270,60

DYN - BTEC or GTEC / DYN / PET
PRODUCT CODE C85 - C80



COVER Black Technora®
 or Gold Technora® / Dyneema® / Polyester.

DYN SK99 HPS + PU			DYN SK78 HPS + PU		
NA20C85 - C80			NA58C85 - C80		
DIAM	B. L.	WEIGHT	DIAM	B. L.	WEIGHT
[mm]	[daN]	[g /m]	[mm]	[daN]	[g /m]
1	-	-	1	-	-
1,5	-	-	1,5	-	-
2	199	4,85	2	243	4,73
2,5	450	5,96	2,5	337	5,73
3	615	7,88	3	500	7,55
3,5	960	9,29	3,5	708	9,26
4	1.444	12,42	4	950	12,30
5	2.200	19,19	5	1.386	19,00
6	2.800	26,23	6	2.250	26,16
7	3.500	38,60	7	2.669	38,22
8	4.282	50,58	8	3.087	50,08
9	6.200	60,97	9	4.995	60,37
10	7.150	72,05	10	5.700	71,34
11	8.950	88,39	11	6.900	87,51
12	9.836	102,55	12	8.550	101,53
13	10.200	120,38	13	9.716	119,00
14	12.446	138,21	14	10.100	136,51
15	14.680	160,51	15	11.600	158,76
16	15.550	182,81	16	13.100	181,00
17	16.495	199,08	17	14.500	197,08
18	18.220	215,28	18	16.000	213,15
20	26.080	269,12	20	20.000	266,46

DYN - KEV / DYN
PRODUCT CODE C68



COVER Kevlar® / Dyneema®.

DYN SK99 HPS + PU			DYN SK78 HPS + PU		
NA20C68			NA58C68		
DIAM	B. L.	WEIGHT	DIAM	B. L.	WEIGHT
[mm]	[daN]	[g /m]	[mm]	[daN]	[g /m]
1	-	-	1	-	-
1,5	-	-	1,5	-	-
2	199	4,94	2	243	4,77
2,5	450	6,08	2,5	337	5,79
3	615	8,04	3	500	7,61
3,5	960	9,48	3,5	708	9,34
4	1.444	12,73	4	950	12,59
5	2.200	19,59	5	1.386	19,40
6	2.800	26,77	6	2.250	26,50
7	3.500	39,19	7	2.669	38,80
8	4.282	51,31	8	3.087	50,80
9	6.200	61,91	9	4.995	61,30
10	7.150	73,23	10	5.700	72,50
11	8.950	89,69	11	6.900	88,80
12	9.836	104,13	12	8.550	103,10
13	10.200	122,11	13	9.716	120,79
14	12.446	140,09	14	10.100	138,70
15	14.680	162,86	15	11.600	161,25
16	15.550	185,64	16	13.100	183,80
17	16.495	202,19	17	14.500	200,15
18	18.220	218,67	18	16.000	216,50
20	26.080	273,31	20	20.000	270,60

DYN - KEV / DYN / PET
PRODUCT CODE C78



COVER Kevlar® / Dyneema® / Polyester.

DYN SK99 HPS + PU			DYN SK78 HPS + PU		
NA20C78			NA58C78		
DIAM	B. L.	WEIGHT	DIAM	B. L.	WEIGHT
[mm]	[daN]	[g /m]	[mm]	[daN]	[g /m]
1	-	-	1	-	-
1,5	-	-	1,5	-	-
2	199	4,80	2	243	4,65
2,5	450	5,90	2,5	337	5,64
3	615	7,80	3	500	7,43
3,5	960	9,20	3,5	708	9,11
4	1.444	12,30	4	950	12,28
5	2.200	19,00	5	1.386	18,81
6	2.800	26,23	6	2.250	26,16
7	3.500	38,60	7	2.669	38,22
8	4.282	50,58	8	3.087	50,08
9	6.200	60,97	9	4.995	60,37
10	7.150	72,05	10	5.700	71,34
11	8.950	88,39	11	6.900	87,51
12	9.836	102,55	12	8.550	101,53
13	10.200	120,38	13	9.716	119,00
14	12.446	138,21	14	10.100	136,51
15	14.680	160,51	15	11.600	158,76
16	15.550	182,81	16	13.100	181,00
17	16.495	199,08	17	14.500	197,08
18	18.220	215,28	18	16.000	213,15
20	26.080	269,12	20	20.000	266,46



Performance line

AVAILABLE CORES

Dyneema® SK78

Treatments: HPS / PU

Dyneema® SK78

Treatment: PU

Dyneema® SK78

Treatments: None

Vectran®

Treatment: PU

AVAILABLE COVERS

Black Technora®

Dyneema®

BTEC / DYN

Black Technora®

Dyneema®

Polyester

BTEC / DYN / PET

Black Technora®

Polyester

BTEC / PET

Kevlar®

Dyneema®

Polyester

KEV / DYN / PET

Cordura®

Polyester

CRD / PET

Polyester

PET

TECHNICAL ROPES FOR RACING BOATS. THIS LINE IS
CONSTANTLY ANALYSED AND UPDATED IN ORDER TO GIVE AN
APPROPRIATE PERFORMANCE TO THE REQUIREMENTS OF THE
MOST DEMANDING CREWS.



Performance line

Armare Performance line products are made with two different fibers that can be eventually completed with different choices of treatment and protective covers.

The table summarises the main features of the fibers used for the construction of braids.

FIBER		Dyneema® SK78	Vectran®
TENACITY	[cN/dTex]	35,10	24,2
MODULUS	[cN/dTex]	1.160	530
CREEP	[-]	Very good	Excellent
SPECIFIC GRAVITY	[Kg/dm³]	0,975	1,410
FUSION TEMP	[°C]	147	330

Available Cores

Dyneema® SK78

100% SK78

HPS TREATMENT

PU COATED TREATMENT

Treatments: HPS / PU

The High Modulus fiber Dyneema® SK78, characterized by a remarkable stability under constant loads, provides the following features: low creep, elevated breaking load, low elongation, light weight, low level of water absorption, high resistance to UV rays and abrasion, great flexibility, high resistance to cutting. The ropes made with Dyneema® SK78 + HPS + PU are therefore destined to extreme performances, especially during highly demanding regattas when the permanent load is continuously present.

Dyneema® SK78

100% SK78

Treatments: None

These ropes are made with the same quantity of Dyneema® SK78 and the same parameters of construction as the previous versions, but have not undergone any type of treatment. This makes them soft, while maintaining all the characteristics of Dyneema® SK78 with slightly lower performance. Given the absence of treatment, it is not advisable to use the rope without a cover. Particularly suitable for ropes when maximum handling over time is required.

Dyneema® SK78

100% SK78

PU COATED TREATMENT

Treatments: PU

This Line of ropes differs from the previous version Dyneema® SK78 + HPS + PU to the lack of the HPS treatment, which means that there is no thermic pre-stretching under load. This makes the rope more manageable, as the core is more supple. It has a slightly different breaking load and elongation in comparison with DYN 78 + HPS + PU, because the braid is not settled (it means that the differences of tensions between fibers are not adjusted). However, its general features remain at a high level, making this rope affordable to boats and crews of a less extreme technical level.

Vectran®

100% VECTRAN

PU COATED TREATMENT

Treatments: PU

The main feature of the Vectran® fiber is having a near zero creep if used under loads up to 50% of the breaking load. Vectran® braids are ideal when used under static loads, e.g. as main sail and genoa halyards, as well as for steering line systems and afterguys. But it's important to remember that the fibre is not resistant to UV rays and therefore it isn't particularly suitable to be used without cover, unless in specific cases protected from the light or if replacements are constantly planned.

Available Covers

Black Technora® / Dyneema®

BTEC / DYN

The mixture of these fibres has been carefully studied to be fairly distributed in order to make them take advantage of their mutual characteristics, both in terms of durability and performance. Excellent results in order of smoothness, abrasion resistance and durability have been reached.

Black Technora® / Dyneema® / Polyester

BTEC / DYN / PET

This item is suitable for many different boats and uses because of its excellent resistance to abrasion and to repeated bending. Compared to TEC/DYN covers, it is easier to customize thanks to the presence of Polyester and it even becomes more recognizable in the distinction of the different manoeuvres.

Black Technora® / Polyester

BTEC / PET

It combines high level functional characteristics, with UV and abrasion resistance as well as a good grip. Thanks to the mixture among the Black Technora® and the different Polyester colours, the look is also winning.

Kevlar® / Dyneema® / Polyester

KEV / DYN / PET

It preserves similar characteristics as its sister-cover BTEC/DYN/PET, but thanks to the high point of fusion of Kevlar® it is more suitable for high speed manoeuvres and load, where the ropes reach high temperatures. It holds one of the best grips but a lower UV resistance in comparison to Black Technora®, which is composed by special pigments that protract the life of the rope, despite of the exposure to UV rays.

Cordura® / Polyester

CRD / PET

This rope stands out for its lightness and perfect grip. It has been studied to obtain an excellent grip on stoppers and winches through the use of special anti-slip fibers.

Polyester

PET

It is the most used fiber on different types of boats thanks to its good resistance to UV rays and to abrasion and for its excellent durability to atmospheric agents. Moreover, it is easy to customize and ideal to diversify the different manoeuvres.

Other covers available: PBO / PET KEV / DYN KEV / PET DYN / PET

DYNEEMA® SK78 + HPS + PU

DYNEEMA® SK78 + HPS + PU - BREAKING LOAD AND WEIGHT COMPARATIVE TABLE

Ø	DYNEFORCE 78 SINGLE BRAID		FOR ALL COVERS	BTEC/DYN	BTEC/DYN/PET	BTEC/PET	KEV/DYN/PET	CRD/PET	PET
	NA58C00								
DIAM	B. L.	WEIGHT	B. L.	WEIGHT	WEIGHT	WEIGHT	WEIGHT	WEIGHT	WEIGHT
[mm]	[daN]	[g /m]	[daN]	[g /m]	[g /m]	[g /m]	[g /m]	[g /m]	[g /m]
1	-	-	-	-	-	-	-	-	-
1,5	708	3,40	-	-	-	-	-	-	-
2	950	4,50	243	4,75	4,73	4,79	4,65	4,65	4,70
2,5	1.155	5,70	337	5,76	5,73	5,81	5,64	5,64	5,70
3	1.386	6,80	500	7,58	7,55	7,65	7,43	7,43	7,50
3,5	1.642	8,20	708	9,29	9,26	9,38	9,11	9,11	9,20
4	2.250	10,10	950	12,52	12,30	12,65	12,28	12,28	12,40
5	3.087	15,30	1.386	19,19	19,00	19,38	18,81	18,81	19,00
6	4.995	24,00	2.250	26,50	26,16	26,70	26,16	25,74	26,00
7	6.400	31,10	2.669	38,80	38,22	38,90	38,22	35,28	36,00
8	7.400	38,20	3.087	50,80	50,08	51,10	50,08	44,74	46,80
9	9.716	51,10	4.995	61,30	60,37	62,00	60,37	59,40	60,00
10	11.600	60,00	5.700	72,50	71,34	72,80	71,34	70,29	71,00
11	13.100	77,00	6.900	88,80	87,51	88,10	87,51	85,00	87,00
12	16.000	94,00	8.550	103,10	101,53	103,60	101,53	100,00	101,00
13	17.780	110,00	9.716	121,00	119,00	121,30	119,00	114,36	116,90
14	20.000	128,00	10.100	138,70	136,51	139,30	136,51	134,44	148,40
15	23.000	145,00	11.600	161,25	158,76	162,00	158,76	156,32	164,20
16	26.300	160,00	13.100	183,80	181,00	184,70	181,00	178,20	180,00
17	29.000	180,00	14.500	200,15	197,08	201,10	197,08	194,05	196,00
18	31.400	200,00	16.000	216,50	213,15	217,50	213,15	209,90	212,00
20	37.000	250,00	20.000	270,60	266,46	271,90	266,46	262,35	265,00

NOTE ABOUT BREAKING LOAD AND DIAMETERS The average values shown above are derived from tests taken at Armare laboratory, on properly spliced new ropes, and may change without notice. Other diameters available on request. The static load of the rope must not exceed 20% of breaking load shown in the table. Knots may affect the breaking load of the rope with reductions of up to 60%. The splicing increases the diameter of the rope of about 1.5 times. The use and exposure to weather conditions, depending from the kind of rope and the time of exposure, can reduce the breaking loads of the ropes.

DYNEFORCE 78 Single Braid

PRODUCT CODE NA58C00



CONSTRUCTION 12 plait with Dyneema® SK78 impregnated with polyurethane coating and special heat treatment HPS.

USE Ideal for tackles, backstays, runners, baby stays, control lines, strops and loops; moreover for lashings where a good breaking load and a low elongation are required.

STANDARD DIAMETERS

From 1,5 to 30 mm

Other diameters on request

STRETCH AT 30% B. L. 2,16%

STRETCH AT B. L. 3,20%

COLOURS

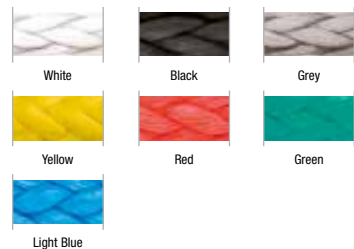

SK78 - BTEC / DYN

PRODUCT CODE NA58C35



COVER Black Technora® / Dyneema®

CORE 12 plait with Dyneema® SK78 impregnated with polyurethane coating and special heat treatment HPS.

USE Ideal for manoeuvres of high fatigue and cyclical mechanical stress, in particular where the wear of the cover is steadily present e.g. jib sheets, tacklines and staysail sheets.

STANDARD DIAMETERS

From 2 to 30 mm

Other diameters on request

STRETCH AT 30% B. L. 2,16%

STRETCH AT B. L. 3,20%

COLOURS Melange Natural Black Technora® / Dyneema®.



SK78 - BTEC / DYN / PET

PRODUCT CODE NA58C85



COVER Black Technora® / Dyneema® / Polyester

CORE 12 plait with Dyneema® SK78 impregnated with polyurethane coating and special heat treatment HPS.

USE It's simple to control and to release on winches. Ideal for jib and gennaker sheets, halyard and control lines.

STANDARD DIAMETERS

From 2 to 30 mm
Other diameters on request

STRETCH AT 30% B. L. 2,16%

STRETCH AT B. L. 3,20%

COLOURS Melange Black Technora® / Dyneema® / Polyester to choose from:



SK78 - BTEC / PET

PRODUCT CODE NA58C86



COVER Black Technora® / Polyester

CORE 12 plait with Dyneema® SK78 impregnated with polyurethane coating and special heat treatment HPS.

USE This rope is used on monotypes, oceanic boats and on Super Yachts as sheets and halyards with a good grip and high chafe resistance.

STANDARD DIAMETERS

From 2 to 30 mm
Other diameters on request

STRETCH AT 30% B. L. 2,16%

STRETCH AT B. L. 3,20%

COLOURS Melange Black Technora® / Polyester to choose from:



SK78 - KEV / DYN / PET

PRODUCT CODE NA58C78



COVER Kevlar® / Dyneema® / Polyester

CORE 12 plait with Dyneema® SK78 impregnated with polyurethane coating and special heat treatment HPS.

USE Ideal for manoeuvres of high fatigue and cyclical mechanical stress e.g. jib sheets, tacklines and staysail sheets.

STANDARD DIAMETERS

From 2 to 30 mm
Other diameters on request

STRETCH AT 30% B. L. 2,16%

STRETCH AT B. L. 3,20%

COLOURS Melange Kevlar® / Dyneema® / Polyester to choose from:



SK78 - CRD / PET

PRODUCT CODE NA58C24



COVER Cordura® / Polyester

CORE 12 plait with Dyneema® SK78 impregnated with polyurethane coating and special heat treatment HPS.

USE Excellent grip on stoppers and winches. It can be chosen either as halyard, as sheet and for all control lines thanks to its soft and grip touch.

STANDARD DIAMETERS

From 2 to 30 mm
Other diameters on request

STRETCH AT 30% B. L. 2,16%

STRETCH AT B. L. 3,20%

COLOURS Melange Cordura® / Polyester to choose from:



SK78 - PET

PRODUCT CODE NA58C71

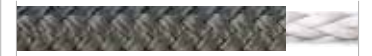

COVER Polyester

CORE 12 plait with Dyneema® SK78 impregnated with polyurethane coating and special heat treatment HPS.

USE Indicated for multiple uses: sheets, halyards and general running rigging.

STANDARD DIAMETERS

From 2 to 30 mm
Other diameters on request

STRETCH AT 30% B. L. 2,16%

STRETCH AT B. L. 3,20%

COLOURS to choose from:



DYNEEMA® SK78 + PU

DYNEEMA® SK78 + PU - BREAKING LOAD AND WEIGHT COMPARATIVE TABLE

Ø	SUPERROUND 78 SINGLE BRAID		FOR ALL COVERS	BTEC/DYN	BTEC/DYN/PET	BTEC/PET	KEV/DYN/PET	CRD/PET	PET
	NA17C00			NA17C35	NA17C85	NA17C86	NA17C78	NA17C24	NA17C71
DIAM	B. L.	WEIGHT	B. L.	WEIGHT	WEIGHT	WEIGHT	WEIGHT	WEIGHT	WEIGHT
[mm]	[daN]	[g /m]	[daN]	[g /m]	[g /m]	[g /m]	[g /m]	[g /m]	[g /m]
1	-	-	-	-	-	-	-	-	-
1,5	-	-	-	-	-	-	-	-	-
2	470	2,43	100	4,34	4,33	4,39	4,26	4,26	4,30
2,5	700	3,80	140	5,76	5,73	5,81	5,64	5,64	5,70
3	920	5,00	300	6,97	6,94	7,04	6,83	6,83	6,90
3,5	1.020	7,50	470	9,39	9,36	9,49	9,21	9,21	9,30
4	1.600	9,80	700	12,52	12,30	12,65	12,28	12,28	12,40
5	2.800	14,40	950	19,29	19,30	19,48	18,91	18,91	19,10
6	4.100	20,00	1.700	26,50	26,17	26,70	26,17	25,74	26,00
7	6.100	27,00	2.600	38,20	37,70	38,50	37,70	37,62	38,00
8	7.150	35,00	2.800	49,90	49,20	50,20	49,20	48,40	48,90
9	8.100	46,00	4.100	60,15	59,30	60,50	59,30	58,41	59,00
10	10.200	57,00	5.470	70,40	69,38	70,80	69,38	68,31	69,00
11	12.100	61,00	6.100	85,75	84,50	86,20	84,48	83,16	87,00
12	15.200	68,00	6.562	101,10	99,57	101,60	99,57	98,00	99,00
13	16.700	73,00	8.100	118,80	117,00	120,55	118,10	115,43	116,60
14	17.850	78,00	9.150	136,60	134,55	137,30	134,55	132,46	133,80
15	20.500	90,00	11.000	154,30	151,98	146,70	151,98	143,55	150,50
16	22.000	102,00	12.100	171,50	168,95	172,40	168,95	166,32	168,00
17	23.600	114,10	13.630	180,10	177,10	181,00	177,10	174,30	176,00
18	25.000	126,00	15.200	187,90	185,02	188,80	185,02	182,16	184,00
20	28.700	160,00	17.850	247,10	243,33	248,30	243,33	239,58	242,00

NOTE ABOUT BREAKING LOAD AND DIAMETERS The average values shown above are derived from tests taken at Armare laboratory, on properly spliced new ropes, and may change without notice. Other diameters available on request. The static load of the rope must not exceed 20% of breaking load shown in the table. Knots may affect the breaking load of the rope with reductions of up to 60%. The splicing increases the diameter of the rope of about 1.5 times. The use and exposure to weather conditions, depending from the kind of rope and the time of exposure, can reduce the breaking loads of the ropes.

SUPERROUND 78 Single Braid

PRODUCT CODE NA17C00



CONSTRUCTION 12 plait with Dyneema® SK78 impregnated with polyurethane coating.

USE Ideal for bindings, leading blocks, control lines and tackles.

STANDARD DIAMETERS

From 2 to 30 mm
Other diameters on request

STRETCH AT 30% B. L. 2,60%
STRETCH AT B. L. 3,60%

COLOURS



SK78 - BTEC / DYN

PRODUCT CODE NA17C35



COVER Black Technora® / Dyneema®

CORE 12 plait with Dyneema® SK78 impregnated with polyurethane coating.

USE Ideal for manoeuvres of high fatigue and cyclical mechanical stress, in particular where the wear of the cover is steadily present e.g. jib sheets, tacklines and staysail sheets.

STANDARD DIAMETERS

From 2 to 30 mm
Other diameters on request

STRETCH AT 30% B. L. 2,60%
STRETCH AT B. L. 3,60%

COLOURS Melange Natural Black Technora® / Dyneema®.



SK78 - BTEC / DYN / PET

PRODUCT CODE NA17C85



100% SK78 PU COATED TREATMENT

COVER Black Technora® / Dyneema® / Polyester

CORE 12 plait with Dyneema® SK78 impregnated with polyurethane coating.

USE It's simple to control and to release on winches. Ideal for jib and gennaker sheets, halyard and control lines.

STANDARD DIAMETERS

From 2 to 30 mm
Other diameters on request

STRETCH AT 30% B. L. 2,60%

STRETCH AT B. L. 3,60%

COLOURS Melange Black Technora® / Dyneema® / Polyester to choose from:



SK78 - BTEC / PET

PRODUCT CODE NA17C86



100% SK78 PU COATED TREATMENT

COVER Black Technora® / Polyester

CORE 12 plait with Dyneema® SK78 impregnated with polyurethane coating.

USE This rope is used on monotypes, oceanic boats and on Super Yachts as sheets and halyards with a good grip and high chafe resistance.

STANDARD DIAMETERS

From 2 to 30 mm
Other diameters on request

STRETCH AT 30% B. L. 2,60%

STRETCH AT B. L. 3,60%

COLOURS Melange Black Technora® / Polyester to choose from:



SK78 - KEV / DYN / PET

PRODUCT CODE NA17C78

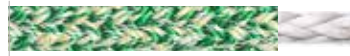

100% SK78 PU COATED TREATMENT

COVER Kevlar® / Dyneema® / Polyester

CORE 12 plait with Dyneema® SK78 impregnated with polyurethane coating.

USE Ideal for manoeuvres of high fatigue and cyclical mechanical stress e.g. jib sheets, tacklines and staysail sheets.

STANDARD DIAMETERS

From 2 to 30 mm
Other diameters on request

STRETCH AT 30% B. L. 2,60%

STRETCH AT B. L. 3,60%

COLOURS Melange Kevlar® / Dyneema® / Polyester to choose from:



SK78 - CRD / PET

PRODUCT CODE NA17C24



100% SK78 PU COATED TREATMENT

COVER Cordura® / Polyester

CORE 12 plait with Dyneema® SK78 impregnated with polyurethane coating.

USE Excellent grip on stoppers and winches. It can be chosen either as halyard, as sheet and for all control lines thanks to its soft and grip touch.

STANDARD DIAMETERS

From 2 to 30 mm
Other diameters on request

STRETCH AT 30% B. L. 2,60%

STRETCH AT B. L. 3,60%

COLOURS Melange Cordura® / Polyester to choose from:



SK78 - PET

PRODUCT CODE NA17C71



100% SK78 PU COATED TREATMENT

COVER Polyester

CORE 12 plait with Dyneema® SK78 impregnated with polyurethane coating.

USE Indicated for multiple uses: sheets, halyards and general running rigging.

STANDARD DIAMETERS

From 2 to 30 mm
Other diameters on request

STRETCH AT 30% B. L. 2,60%

STRETCH AT B. L. 3,60%

COLOURS to choose from:



DYNEEMA® SK78

DYNEEMA® SK78 - BREAKING LOAD AND WEIGHT COMPARATIVE TABLE

Ø	LIGHT 78 SINGLE BRAID		FOR ALL COVERS	BTEC/DYN	BTEC/DYN/PET	BTEC/PET	KEV/DYN/PET	CRD/PET	PET
	NA48C00								
DIAM	B. L.	WEIGHT	B. L.	WEIGHT	WEIGHT	WEIGHT	WEIGHT	WEIGHT	WEIGHT
[mm]	[daN]	[g /m]	[daN]	[g /m]	[g /m]	[g /m]	[g /m]	[g /m]	[g /m]
1	-	-	-	-	-	-	-	-	-
1,5	264	1,60	69	-	-	-	-	-	-
2	414	2,50	88	-	-	-	-	-	-
2,5	616	3,08	123	-	-	-	-	-	-
3	836	3,70	264	-	-	-	-	6,80	6,87
3,5	900	4,90	414	9,28	9,24	9,37	9,10	9,10	9,19
4	1.500	7,40	616	12,44	12,42	12,56	12,20	12,20	12,32
5	2.464	9,60	900	18,90	18,81	19,07	18,89	18,70	18,89
6	3.608	14,10	1.500	25,76	25,65	26,01	25,25	25,49	25,76
7	5.368	21,00	2.288	37,07	36,92	37,43	36,37	36,69	37,07
8	6.292	27,40	2.464	48,38	48,20	48,86	47,42	47,89	48,38
9	7.128	35,00	3.608	58,33	58,12	58,91	57,17	57,74	58,33
10	8.970	42,10	5.368	68,28	68,03	68,95	66,92	67,59	68,28
11	10.648	49,00	6.039	-	-	-	-	-	-
12	12.760	55,90	6.292	98,00	97,58	97,94	96,03	96,99	97,97
13	14.696	61,25	7.128	-	-	-	-	-	-
14	15.708	66,60	8.970	132,40	131,62	133,70	130,00	131,09	132,41
15	16.456	71,50	10.648	-	-	-	-	-	-
16	19.360	76,40	11.994	166,25	165,60	167,90	163,00	164,58	166,25
17	20.768	88,20	12.760	-	-	-	-	-	-
18	22.000	100,00	14.696	182,10	181,40	183,91	178,50	180,29	182,10
20	25.256	123,50	16.456	240,00	233,65	241,96	234,83	237,18	239,57

NOTE ABOUT BREAKING LOAD AND DIAMETERS The average values shown above are derived from tests taken at Armare laboratory, on properly spliced new ropes, and may change without notice. Other diameters available on request. The static load of the rope must not exceed 20% of breaking load shown in the table. Knots may affect the breaking load of the rope with reductions of up to 60%. The splicing increases the diameter of the rope of about 1.5 times. The use and exposure to weather conditions, depending from the kind of rope and the time of exposure, can reduce the breaking loads of the ropes.

LIGHT 78 Single Braid

PRODUCT CODE NA48C00



100%
SK78

CONSTRUCTION 12 plait with Dyneema® SK78.

USE Ideal to build the tack points on sails.

STANDARD DIAMETERS

From 1,5 to 30 mm

Other diameters on request

STRETCH AT 30% B. L. 2,80%

STRETCH AT B. L. 3,80%

COLOURS Natural white (without treatments).



White

SK78 - BTEC / DYN

PRODUCT CODE NA48C35



100%
SK78

COVER Black Technora® / Dyneema®

CORE 12 plait with Dyneema® SK78.

USE Ideal for manoeuvres of high fatigue and cyclical mechanical stress, in particular where the wear of the cover is steadily present e.g. jib sheets, tacklines and staysail sheets.

STANDARD DIAMETERS

From 3,5 to 30 mm

Other diameters on request

STRETCH AT 30% B. L. 2,16%

STRETCH AT B. L. 3,80%

COLOURS Melange Natural Black Technora® / Dyneema®.



BTEC / DYN

SK78 - BTEC / DYN / PET

PRODUCT CODE NA48C85



100% SK78

COVER Black Technora® / Dyneema® / Polyester

CORE 12 plait with Dyneema® SK78.

USE It's simple to control and to release on winches. Ideal for jib and gennaker sheets, halyard and control lines.

STANDARD DIAMETERS

From 3,5 to 30 mm

Other diameters on request

STRETCH AT 30% B. L. 2,16%

STRETCH AT B. L. 3,80%

COLOURS Melange Black Technora® / Dyneema® / Polyester to choose from:



SK78 - BTEC / PET

PRODUCT CODE NA48C86



100% SK78

COVER Black Technora® / Polyester

CORE 12 plait with Dyneema® SK78.

USE This rope is used on monotypes, oceanic boats and on Super Yachts as sheets and halyards with a good grip and high chafe resistance.

STANDARD DIAMETERS

From 3,5 to 30 mm

Other diameters on request

STRETCH AT 30% B. L. 2,16%

STRETCH AT B. L. 3,80%

COLOURS Melange Black Technora® / Polyester to choose from:



SK78 - KEV / DYN / PET

PRODUCT CODE NA48C78

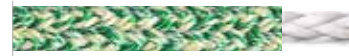

100% SK78

COVER Kevlar® / Dyneema® / Polyester

CORE 12 plait with Dyneema® SK78.

USE Ideal for manoeuvres of high fatigue and cyclical mechanical stress e.g. jib sheets, tacklines and staysail sheets.

STANDARD DIAMETERS

From 3,5 to 30 mm

Other diameters on request

STRETCH AT 30% B. L. 2,16%

STRETCH AT B. L. 3,80%

COLOURS Melange Kevlar® / Dyneema® / Polyester to choose from:



SK78 - CRD / PET

PRODUCT CODE NA48C24_CP



100% SK78

COVER Cordura® / Polyester

CORE 12 plait with Dyneema® SK78.

USE Excellent grip on stoppers and winches. It can be chosen either as halyard, as sheet and for all control lines thanks to its soft and grip touch.

STANDARD DIAMETERS

From 3 to 30 mm

Other diameters on request

STRETCH AT 30% B. L. 2,16%

STRETCH AT B. L. 3,80%

COLOURS Melange Cordura® / Polyester to choose from:



SK78 - PET

PRODUCT CODE NA48C71

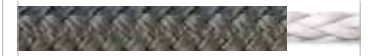

100% SK78

COVER Polyester

CORE 12 plait with Dyneema® SK78.

USE Indicated for multiple uses: sheets, halyards and general running rigging.

STANDARD DIAMETERS

From 3 to 30 mm

Other diameters on request

STRETCH AT 30% B. L. 2,16%

STRETCH AT B. L. 3,80%

COLOURS to choose from:



VECTRAN® + PU

VECTRAN® + PU - BREAKING LOAD AND WEIGHT COMPARATIVE TABLE

Ø	VEC-TEC SINGLE BRAID		FOR ALL COVERS	BTEC/DYN	BTEC/DYN/PET	BTEC/PET	KEV/DYN/PET	CRD/PET	PET
	NA55C00								
DIAM	B. L.	WEIGHT	B. L.	WEIGHT	WEIGHT	WEIGHT	WEIGHT	WEIGHT	WEIGHT
[mm]	[daN]	[g /m]	[daN]	[g /m]	[g /m]	[g /m]	[g /m]	[g /m]	[g /m]
1	-	-	-	-	-	-	-	-	-
1,5	-	-	-	-	-	-	-	-	-
2	430	3,10	160	-	-	-	-	4,06	4,10
2,5	640	4,50	220	-	-	-	-	5,64	5,70
3	860	6,10	430	-	-	-	-	7,33	7,40
3,5	1.350	9,50	640	-	-	-	-	9,90	10,00
4	1.880	11,90	860	-	-	-	-	13,37	13,50
5	2.760	18,00	1.350	-	-	-	-	20,89	21,10
6	3.800	25,00	1.795	28,70	28,22	28,80	28,22	27,82	28,10
7	-	-	-	-	-	-	-	-	-
8	6.760	44,50	2.760	55,00	54,19	55,30	54,19	53,36	53,90
9	-	-	-	-	-	-	-	-	-
10	10.000	74,00	5.300	77,60	76,44	78,00	76,44	75,24	76,00
11	-	-	-	-	-	-	-	-	-
12	12.540	85,00	7.970	112,30	110,64	112,90	110,64	108,90	110,00
13	-	-	-	-	-	-	-	-	-
14	15.450	107,00	10.000	154,00	151,61	154,70	151,61	149,29	150,80
15	-	-	-	-	-	-	-	-	-
16	18.530	127,00	12.540	188,90	186,00	189,80	186,00	183,15	185,00
17	-	-	-	-	-	-	-	-	-
18	20.900	166,00	15.450	217,50	214,13	218,50	214,13	210,87	213,00
20	23.360	210,00	18.530	272,60	268,42	273,90	268,42	264,33	267,00

NOTE ABOUT BREAKING LOAD AND DIAMETERS The average values shown above are derived from tests taken at Armare laboratory, on properly spliced new ropes, and may change without notice. Other diameters available on request. The static load of the rope must not exceed 20% of breaking load shown in the table. Knots may affect the breaking load of the rope with reductions of up to 60%. The splicing increases the diameter of the rope of about 1.5 times. The use and exposure to weather conditions, depending from the kind of rope and the time of exposure, can reduce the breaking loads of the ropes.

VEC-TEC Single Braid

PRODUCT CODE NA55C00



100% VECTRAN PU COATED TREATMENT

CONSTRUCTION 12 plait in Vectran® with polyurethane coating.

USE Ideal for luff and leech lines, furling cables, steering gear and control lines if protected from UV rays below deck or hidden inside of the sail.

STANDARD DIAMETERS

From 2 to 26 mm
Other diameters on request

STRETCH AT 30% B. L. 2,60%
STRETCH AT B. L. 3,60%

COLOURS



Vectran® Natural



Vectran® Silver Grey

VEC - BTEC / DYN

PRODUCT CODE NA55C35



100% VECTRAN PU COATED TREATMENT

COVER Black Technora® / Dyneema®

CORE 12 plait in Vectran® with polyurethane coating.

USE Ideal for manoeuvres of high fatigue and cyclical mechanical stress, in particular where the wear of the cover is steadily present e.g. jib sheets, tacklines and staysail sheets.

STANDARD DIAMETERS

From 6 to 30 mm
Other diameters on request

STRETCH AT 30% B. L. 2,60%
STRETCH AT B. L. 3,60%

COLOURS Melange Natural Black Technora® / Dyneema®



BTEC / DYN

VEC - BTEC / DYN / PET

PRODUCT CODE NA55C85



100% VECTRAN PU COATED TREATMENT

COVER Black Technora® / Dyneema® / Polyester

CORE 12 plait in Vectran® with polyurethane coating.

USE It's simple to control and to release on winches. Ideal for jib and gennaker sheets, halyard and control lines.

STANDARD DIAMETERS

From 6 to 30 mm
Other diameters on request

STRETCH AT 30% B. L. 2,60%

STRETCH AT B. L. 3,60%

COLOURS Melange Black Technora® / Dyneema® / Polyester to choose from:



VEC - BTEC / PET

PRODUCT CODE NA55C86



100% VECTRAN PU COATED TREATMENT

COVER Black Technora® / Polyester

CORE 12 plait in Vectran® with polyurethane coating.

USE This rope is used on monotypes, oceanic boats and on Super Yachts as sheets and halyards with a good grip and high chafe resistance.

STANDARD DIAMETERS

From 6 to 30 mm
Other diameters on request

STRETCH AT 30% B. L. 2,60%

STRETCH AT B. L. 3,60%

COLOURS Melange Black Technora® / Polyester to choose from:



VEC - KEV / DYN / PET

PRODUCT CODE NA55C78



100% VECTRAN PU COATED TREATMENT

COVER Kevlar® / Dyneema® / Polyester

CORE 12 plait in Vectran® with polyurethane coating.

USE Ideal for manoeuvres of high fatigue and cyclical mechanical stress e.g. jib sheets, tacklines and staysail sheets.

STANDARD DIAMETERS

From 6 to 30 mm
Other diameters on request

STRETCH AT 30% B. L. 2,60%

STRETCH AT B. L. 3,60%

COLOURS Melange Kevlar® / Dyneema® / Polyester to choose from:



VEC - CRD / PET

PRODUCT CODE NA55C24



100% VECTRAN PU COATED TREATMENT

COVER Cordura® / Polyester

CORE 12 plait in Vectran® with polyurethane coating.

USE Excellent grip on stoppers and winches. It can be chosen either as halyard, as sheet and for all control lines thanks to its soft and grip touch.

STANDARD DIAMETERS

From 2 to 30 mm
Other diameters on request

STRETCH AT 30% B. L. 2,60%

STRETCH AT B. L. 3,60%

COLOURS Melange Cordura® / Polyester to choose from:



VEC - PET

PRODUCT CODE NA55C71



100% VECTRAN PU COATED TREATMENT

COVER Polyester

CORE 12 plait in Vectran® with polyurethane coating.

USE Indicated for multiple uses: sheets, halyards and general running rigging.

STANDARD DIAMETERS

From 2 to 30 mm
Other diameters on request

STRETCH AT 30% B. L. 2,60%

STRETCH AT B. L. 3,60%

COLOURS to choose from:



Cruising line

The different compositions of the cores, some with high modulus fibers such as Dyneema® SK78, matched with specific protective covers, make up a full and highly differentiated range of ropes, that can be used as sheets, halyards, tackles, vang, or after guys. In order to help shipowners and professionals in the choice of the most suitable rope, every product is completed by specific use tips. Furthermore, the possibility to make custom-color ropes while keeping unchanged the qualitative features, allows us to meet any type of aesthetic requirement, with exceptional results of application.

<u>Fast cruiser</u>	<u>Daily cruiser</u>	<u>Classic cruiser</u>
<p>Destination Cruiser Boats Club Racing Boats Fast Cruiser Boats</p> <p>Use Halyards / Sheets</p> <p>Products Light 78 Plus Light 78 Fast Topspeed Speedplus</p>	<p>Destination Cruiser Boats Daily Cruiser Boats</p> <p>Use Sheets</p> <p>Products Speedcruise</p>	<p>Destination Classic Cruiser Boats</p> <p>Use Sheets / Halyards</p> <p>Products Star Plus Star Bora Static Armony</p>

ARMARE CRUISING LINE ROPES ARE THE BEST CHOICE FOR ALL THE RUNNING RIGGING OF CRUISING BOATS. THESE LINES DERIVE FROM THE EXPERIENCE GAINED THROUGH RACINGS, REFINED WITH THE BEST CONSTRUCTION TECHNIQUES, IN ORDER TO GET HIGH PERFORMANCE, QUALITY, DURABILITY AND SAFETY WHILE KEEPING THE COST OF THE FINAL PRODUCT UNDER CONTROL.



CRUISING - BREAKING LOAD AND WEIGHT COMPARATIVE TABLE

Ø	LIGHT 78 PLUS		LIGHT 78 FAST		TOPSPEED		SPEEDPLUS		SPEEDCRUISE		STAR PLUS		STAR		BORA		STATIC		ARMONY	
	NA48C24		NA48C71_FST		NA89C24		NA36C24		NA36C71		NA37C24		NA44		N003		NA38		NA71	
DIAMETER	B. L.	WEIGHT	B. L.	WEIGHT	B. L.	WEIGHT	B. L.	WEIGHT	B. L.	WEIGHT	B. L.	WEIGHT	B. L.	WEIGHT	B. L.	WEIGHT	B. L.	WEIGHT	B. L.	WEIGHT
[mm]	[daN]	[g /m]	[daN]	[g /m]	[daN]	[g /m]	[daN]	[g /m]	[daN]	[g /m]	[daN]	[g /m]	[daN]	[g /m]	[daN]	[g /m]	[daN]	[g /m]	[daN]	[g /m]
1	-	-	-	-	-	-	-	-	-	-	-	-	-	-	-	-	-	-	-	-
1,5	-	-	-	-	-	-	-	-	-	-	-	-	-	-	-	-	-	-	-	-
2	-	-	-	-	-	-	-	-	-	-	-	-	-	-	-	-	-	-	-	-
2,5	-	-	-	-	-	-	-	-	-	-	-	-	-	-	-	-	-	-	-	-
3	-	-	-	-	-	-	-	-	-	-	260	11,00	250	10,00	-	-	-	-	-	-
3,5	-	-	-	-	-	-	-	-	-	-	-	-	-	-	-	-	-	-	-	-
4	600	12,08	600	12,20	-	-	-	-	-	-	470	15,84	450	15,00	340	16,00	-	-	250	10,00
5	880	18,51	880	18,70	-	-	-	-	-	-	680	24,75	650	23,00	574	23,00	-	-	395	18,00
6	1.400	25,24	1.400	25,50	1.150	26,42	1.100	25,74	1.100	26,00	945	30,69	900	30,00	834	29,00	790	32,00	560	22,00
7	2.059	36,33	2.059	36,70	-	-	-	-	-	-	1.260	39,60	1.200	39,00	-	-	-	-	-	-
8	2.415	47,42	2.415	47,90	1.933	47,75	1.850	46,53	1.850	47,00	1.630	49,50	1.550	49,00	1.111	50,00	1.350	55,00	1.000	41,00
9	3.150	57,17	3.150	57,70	-	-	-	-	-	-	-	-	-	-	-	-	-	-	-	-
10	4.600	66,92	4.600	67,60	3.031	74,17	2.900	72,27	2.900	73,00	2.570	75,24	2.450	75,00	2.100	75,00	2.100	78,00	1.500	62,00
11	-	-	-	-	-	-	-	-	-	-	-	-	-	-	-	-	-	-	-	-
12	6.120	96,03	6.120	97,00	5.016	96,52	4.800	94,05	4.800	95,00	3.460	103,95	3.300	103,00	2.793	104,00	2.900	105,00	1.950	86,00
13	-	-	-	-	-	-	-	-	-	-	-	-	-	-	-	-	-	-	-	-
14	8.791	129,79	8.791	131,10	6.375	136,14	6.100	132,66	6.100	134,00	4.700	147,51	4.500	148,00	3.277	145,00	4.050	145,00	2.500	115,00
15	-	-	-	-	-	-	-	-	-	-	-	-	-	-	-	-	-	-	-	-
16	11.755	162,95	11.755	164,60	8.778	174,75	8.400	170,28	8.400	172,00	6.300	197,01	6.000	198,00	4.615	187,00	5.200	188,00	3.000	143,00
18	14.402	178,50	14.402	180,30	10.973	225,55	10.500	219,78	10.500	222,00	7.700	237,60	7.400	240,00	5.433	242,00	-	-	3.600	202,00
20	16.127	234,83	16.127	237,20	12.645	282,45	12.100	275,22	12.100	278,00	9.550	277,20	9.100	280,00	-	-	-	-	4.200	250,00

NOTE ABOUT BREAKING LOAD AND DIAMETERS The average values shown above are derived from tests taken at Armare laboratory, on properly spliced new ropes, and may change without notice. Other diameters available on request. The static load of the rope must not exceed 20% of breaking load shown in the table. Knots may affect the breaking load of the rope with reductions of up to 60%. The splicing increases the diameter of the rope of about 1.5 times. The use and exposure to weather conditions, depending from the kind of rope and the time of exposure, can reduce the breaking loads of the ropes.



Light 78 Plus

PRODUCT CODE NA48C24



100% SK78

CONSTRUCTION Double braid
COVER Cordura® / Polyester
CORE Dyneema® SK78

FEATURES AND USE It guarantees lightness, high breaking load, minimum elongation and excellent grip on stopper and winch, thanks to the use of special anti-slip fibers. Ideal as halyard, but suitable also as sheet, due to its handy construction.

STANDARD DIAMETERS

From 4 to 22 mm
 Other diameters on request

STRETCH AT 30% B. L. 2,80%
STRETCH AT B. L. 3,80%

COLOURS Solid colour white (CRD/ white PET) or Melange white / colored PET:



Light 78 Fast

PRODUCT CODE NA48C71_FST



100% SK78

CONSTRUCTION Double braid
COVER Polyester
CORE Dyneema® SK78

FEATURES AND USE High breaking load, excellent stability under constant load, minimal elongation. Suggested use for halyard, topping, tackle and control line.

STANDARD DIAMETERS

From 4 to 22 mm
 Other diameters on request

STRETCH AT 30% B. L. 2,80%
STRETCH AT B. L. 3,80%

COLOURS Solid colour



Topspeed

PRODUCT CODE NA89C24

NEW



100% HMPE
 PU COATED
 POLYESTER

CONSTRUCTION Double braid
COVER Cordura® / Polyester
CORE HMPE + PU

FEATURES AND USE More shape stability and core duration, thanks to the impregnation with a special PU Coating, which brings a significant increase of the breaking load and a reduction of the elongation. Recommended for all those maneuvers on cruise boats which are exposed to intensive use.

STANDARD DIAMETERS

From 4 to 20 mm
 Other diameters on request

STRETCH AT 30% B. L. 3,70 %
STRETCH AT B. L. 5,25 %

COLOURS Solid colour white (CRD/ white PET) or Melange white / colored PET:

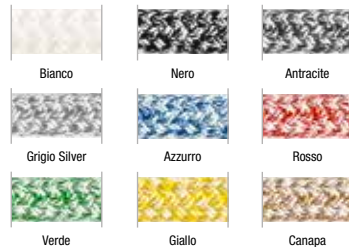

Speedplus

PRODUCT CODE NA36C24



100% HMPE

CONSTRUCTION Double braid
COVER Cordura® / Polyester
CORE HMPE

FEATURES AND USE It is the best possible quality/price compromise of our Cruising Line. It has as a very good breaking load (higher than products in Polyester), a low elongation and a good grip thanks to the special anti-slip cover. It is suitable to be used either as halyard or as sheet.

STANDARD DIAMETERS

From 6 to 22 mm
 Other diameters on request

STRETCH AT 30% B. L. 4,00%
STRETCH AT B. L. 5,60%

COLOURS Solid colour white (CRD/ white PET) or Melange white / colored PET:

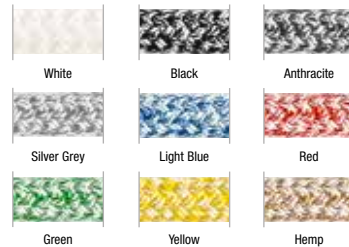

Speedcruise

PRODUCT CODE NA36C71



100% HMPE

CONSTRUCTION Double braid
COVER Polyester
CORE HMPE

FEATURES AND USE Good breaking load, low elongation, durability. Excellent quality / price ratio. Suggested use for halyard, afterguy, sheet and tackle.

STANDARD DIAMETERS

From 6 to 22 mm
 Other diameters on request

STRETCH AT 30% B. L. 4,00%
STRETCH AT B. L. 5,60%

COLOURS Solid colour - Mix - Melange - Marker

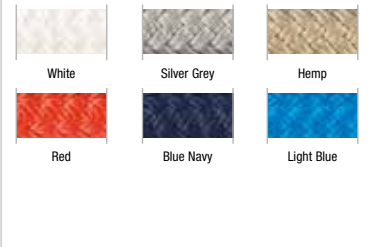

Star Plus

PRODUCT CODE NA37C24



CONSTRUCTION Prestretched double braid
COVER Cordura® / Polyester
CORE Polyester

FEATURES AND USE Stable but flexible, it withstands the use on stoppers and winches and preserves an unchanged softness. It has a better grip than Star, thanks to the use of special anti-slip fibres. It is recommended to be used as halyard, running line, tackle and main outhaul.

STANDARD DIAMETERS

From 3 to 20 mm
Other diameters on request

STRETCH AT 30% B. L. 5,5%
STRETCH AT B. L. 12,00%

COLOURS Solid colour white (CRD/ white PET) or Melange white / colored PET:



Star

PRODUCT CODE NA44



CONSTRUCTION Prestretched double braid
COVER Polyester
CORE Polyester

FEATURES AND USE Soft and flexible, high durability to use and resistance to abrasion. It remains supple over time. Recommended use: halyard, sheet, tackle and control line.

STANDARD DIAMETERS

From 3 to 26 mm
Other diameters on request

STRETCH AT 30% B. L. 7,00%
STRETCH AT B. L. 13,50%

COLOURS Solid colour - Mix - Melange - Marker.



Bora

PRODUCT CODE N003



CONSTRUCTION Heat fixed double braid
COVER Polyester
CORE Polyester

FEATURES AND USE Excellent resistance to abrasion due to its compact design. Good overall qualities of breaking load and elongation. Suggested to be used as halyard, topping, tackle and control line.

STANDARD DIAMETERS

From 4 to 18 mm
Other diameters on request

STRETCH AT 30% B. L. 6,20%
STRETCH AT B. L. 12,80%

COLOURS



Static

PRODUCT CODE NA38



CONSTRUCTION Double braid
COVER Polyester
CORE Unidirectional Polyester yarn core

FEATURES AND USE Very static unidirectional construction, wear-resistant in stoppers and winches, more rigid than the Star. Excellent quality / price ratio. Used as halyard, topping, afterguay.

STANDARD DIAMETERS

From 6 to 16 mm
Other diameters on request

STRETCH AT 30% B. L. 5,00%
STRETCH AT B. L. 11,50%

COLOURS



Armony

PRODUCT CODE NA71



CONSTRUCTION Double braid
COVER Matt Polyester
CORE Polyester

FEATURES AND USE The traditional seafarers choice, thanks to its easy grip and guaranteed hold even when the rope is wet. Good rubbing resistance. Suggested use on cruising boats and dinghies as sheet, control line and reef line.

STANDARD DIAMETERS

From 4 to 20 mm
Other diameters on request

STRETCH AT 30% B. L. 8,00%
STRETCH AT B. L. 13,50%

COLOURS



Kite & Surf line



KITE LINES, SPECIFICALLY DEVELOPED AND DESIGNED FOR KITEBOARDERS, BOTH SPORTY AND PROFESSIONAL. TESTS MADE IN LABORATORY AS WELL AS A LOT OF SESSION DAYS OF FIELD EXPERIENCE PERFORMED BY THE BEST ATHLETES, HAVE GIVEN ARMARE AN IMPORTANT KNOWLEDGE AND KNOW-HOW TO ACHIEVE A COMPLETE LINE OF PRODUCTS.

THESE ROPES, WITH VERY HIGH BREAKING LOAD AND LOW STRETCH, ARE STUDIED TO HAVE A GREAT ABRASION RESISTANCE AND TO EXALT THE PERFORMANCE OF THE KITE. TAKE THE OPPORTUNITY TO FULLY ENJOY YOUR FAVORITE SPORT BY CHOOSING QUALIFIED ARMARE ROPES PRODUCTS.

Dyneforce 99 for Kite

PRODUCT CODE NA20C00



COMPOSITION Single braid in Dyneema® SK99 + HPS and PU coating treatment.

USE Ideal to be used on control lines of professional kitesurf.

ELONGATION AT WORKING LOAD 1,45%

DIAM	B. L.	ROLL LENGHT
[mm]	[daN]	[m]
1	199	200
1,25	314	200
1,5	450	200

COLOURS Solid colour

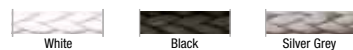

Kitedyne HPS

PRODUCT CODE TT77C00



COMPOSITION Single braid in Dyneema® SK75 + HPS and PU coating treatment.

USE Ideal to be used on control lines of performace kitesurf.

ELONGATION AT WORKING LOAD 1,70%

DIAM	B. L.	ROLL LENGHT
[mm]	[daN]	[m]
1,3	210	300
1,5	275	200
1,7	305	200
1,9	385	200

COLOURS Solid colour

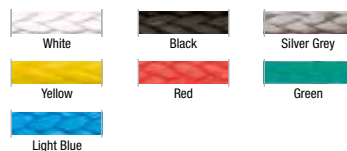

Kitedyne

PRODUCT CODE TT67C00



COMPOSITION Single braid in Dyneema® SK75 + PU coating treatment.

USE Ideal to be used on control lines of kitesurf.

ELONGATION AT WORKING LOAD 1,95%

DIAM	B. L.	ROLL LENGHT
[mm]	[daN]	[m]
0,3	18	500
0,4	39	500
0,5	50	500
0,6	70	400
0,8	78	400
0,9	100	400
1	140	300
1,3	195	300
1,5	250	200
1,7	287	200
1,9	315	200

COLOURS Solid colour

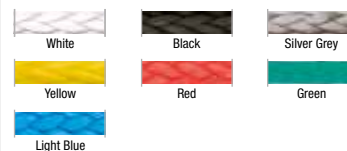

Depower

PRODUCT CODE TT94C48



COMPOSITION Round braid in 100% Dyneema® SK78.

USE Used to hauling out/down the sail during Windsurfing, this rope keeps its round shape.

ELONGATION AT WORKING LOAD 1,95%

DIAM	B. L.	ROLL LENGHT
[mm]	[daN]	[m]
3,8	620	200
4,5	760	200

COLOURS Solid colour



Classic line

COMPLETE RANGE OF ROPES FOR THE MOORING, THE ANCHORING AND THE RUNNING RIGGING OF CLASSIC SAILING BOATS. VINTAGE BOATS OFTEN NEED ROPES OF A TECHNICAL AND QUALITATIVE LEVEL WHICH IS SUPERIOR TO THOSE OF MODERN BOATS. THIS IS BECAUSE THE VOLUMES, THE WATER LINES, THE WEIGHTS, THE SAIL AREA AND THE DECK RIGGING INFLICT A HEAVY DUTY ON RIGGING LINES.



CLASSIC RUNNING RIGGING - BREAKING LOAD AND WEIGHT COMPARATIVE TABLE

Ø	DYN 78 HPS PU - PET		LIGHT 78 FAST		STAR		FENDER BRAID	
	NA58C71		NA48C71_FST		NA44		N021	
	B. L.	WEIGHT	B. L.	WEIGHT	B. L.	WEIGHT	B. L.	WEIGHT
[mm]	[daN]	[g /m]	[daN]	[g /m]	[daN]	[g /m]	[daN]	[g /m]
1	-	-	-	-	-	-	-	-
1,5	-	-	-	-	-	-	-	-
2	243	4,70	-	-	-	-	-	-
2,5	337	5,70	-	-	-	-	-	-
3	500	7,50	-	-	250	10,00	-	-
3,5	708	9,20	-	-	-	-	-	-
4	950	12,40	600	12,20	450	15,00	-	-
5	1.386	19,00	880	18,70	650	23,00	-	-
6	2.250	26,00	1.400	25,50	900	30,00	-	-
7	2.669	36,00	2.059	36,70	1.200	39,00	-	-
8	3.087	46,80	2.415	47,90	1.550	49,00	1.500	38,00
9	4.995	60,00	3.150	57,70	-	-	-	-
10	5.700	71,00	4.600	67,60	2.450	75,00	1.900	78,00
11	6.900	87,00	-	-	-	-	-	-
12	8.550	101,00	6.120	97,00	3.300	103,00	2.150	88,00
13	9.716	116,90	-	-	-	-	-	-
14	10.100	148,40	8.791	131,10	4.500	148,00	2.630	100,00
15	11.600	164,20	-	-	-	-	-	-
16	13.100	180,00	11.755	164,60	6.000	198,00	3.450	112,00
18	16.000	212,00	14.402	180,30	7.400	240,00	-	-
20	20.000	265,00	16.127	237,20	9.100	280,00	-	-

Note: special colors for Classic line only hemp and beige

CLASSIC MOORING ROPES - BREAKING LOAD AND WEIGHT COMPARATIVE TABLE

Ø	STORM LINE		ROUND LINE		SQUARE LINE		SEA KING	
	N020		NA40		NA41		NA42	
	B. L.	WEIGHT	B. L.	WEIGHT	B. L.	WEIGHT	B. L.	WEIGHT
[mm]	[daN]	[g /m]	[daN]	[g /m]	[daN]	[g /m]	[daN]	[g /m]
2,5	-	-	-	-	-	-	-	-
3	-	-	-	-	-	-	300	9,00
3,5	-	-	-	-	-	-	-	-
4	-	-	-	-	-	-	470	16,00
5	-	-	-	-	-	-	600	22,00
6	-	-	-	-	-	-	700	28,00
7	-	-	-	-	-	-	-	-
8	2.000	46,00	-	-	-	-	1.270	48,00
9	-	-	-	-	-	-	-	-
10	2.650	68,00	-	-	1.600	71,00	1.680	70,00
11	-	-	-	-	-	-	-	-
12	3.500	97,00	-	-	2.100	92,00	2.800	103,00
14	4.200	134,00	-	-	2.900	128,00	3.600	140,00
16	4.900	144,00	4.160	170,00	3.500	152,00	4.300	185,00
18	5.400	188,00	5.018	195,00	4.100	170,00	5.400	230,00
20	8.500	288,00	5.460	240,00	4.500	225,00	6.700	290,00
22	11.600	365,00	6.045	305,00	5.000	255,00	8.300	320,00
24	13.500	441,00	6.890	350,00	5.700	290,00	9.700	437,00
26	14.600	510,00	8.099	421,00	6.500	360,00	11.100	500,00
28	18.500	575,00	10.465	550,00	8.400	380,00	12.050	565,00
30	20.000	640,00	11.648	630,00	9.650	470,00	13.400	650,00
32	23.600	890,00	12.350	710,00	10.870	560,00	15.400	740,00
36	25.500	1.130,00	15.600	850,00	13.700	640,00	19.000	900,00
40	31.000	1.280,00	17.500	1.160,00	15.580	830,00	23.500	1.150
44	36.000	1.470,00	20.000	1.450,00	19.400	1.050,00	-	-
48	40.800	1.760,00	-	-	23.300	1.200,00	-	-
52	49.900	2.050,00	-	-	28.100	1.320,00	-	-

Note: special colors for Classic line only hemp and beige

NOTE ABOUT BREAKING LOAD AND DIAMETERS The average values shown above are derived from tests taken at Armare laboratory, on properly spliced new ropes, and may change without notice. Other diameters available on request. The static load of the rope must not exceed 20% of breaking load shown in the table. Knots may affect the breaking load of the rope with reductions of up to 60%. The splicing increases the diameter of the rope of about 1.5 times. The use and exposure to weather conditions, depending from the kind of rope and the time of exposure, can reduce the breaking loads of the ropes.

Dyn 78 HPS PU - Pet

PRODUCT CODE NA58C71



CONSTRUCTION Double braid

COVER Polyester

CORE Dyneema® SK78 + HPS + PU treatment

FEATURES AND USE Maximum breaking load, excellent stability and strength, minimum elongation and lightweight.

Suggested use for halyards, sheets, afterguys, runner backstays and tackles. Large diameters could be used on Super Yachts.

STANDARD DIAMETERS

From 2 to 30 mm

Other diameters on request

STRETCH AT 30% B. L. 2,35%

STRETCH AT B. L. 3,35%

COLOURS



Hemp

Beige

Light 78 Fast

PRODUCT CODE NA48C71_FST



CONSTRUCTION Double braid

COVER Polyester

CORE Dyneema® SK78

FEATURES AND USE High breaking load, excellent stability under constant load, minimal elongation.

Suggested use for halyards, toppings, tackles and control lines. Large diameters could be used on Super Yachts.

STANDARD DIAMETERS

From 4 to 22 mm

Other diameters on request

STRETCH AT 30% B. L. 2,80%

STRETCH AT B. L. 3,80%

COLOURS



Hemp

Beige

Star

PRODUCT CODE NA44



CONSTRUCTION Prestretched double braid

COVER Polyester

CORE Polyester

FEATURES AND USE Soft and flexible, high durability to use and resistance to abrasion. It remains supple over time.

Suggested use for halyards, sheets, tackles and control lines. Large diameters could be used on Super Yachts.

STANDARD DIAMETERS

From 3 to 26 mm

Other diameters on request

STRETCH AT 30% B. L. 7,00%

STRETCH AT B. L. 13,50%

COLOURS



Hemp

Beige

Fender Braid

PRODUCT CODE N021



CONSTRUCTION 24 plait Polyester braid

COVER Polyester

CORE None

FEATURES AND USE It is supple, resistant and has a good knot retention.

Rope ideal for fender.

STANDARD DIAMETERS

From 8 to 16 mm

Other diameters on request

COLOURS



Hemp

Beige

Storm Line

PRODUCT CODE N020



CONSTRUCTION

Balanced twist Polyester braided core,
Polyester cover

FEATURES AND USE

Ideal for Super Yachts but also for emergency or long moorings of small and medium sized boats.

STANDARD DIAMETERS

From 8 to 52 mm
Other diameters on request

COLOURS



Hemp

Beige

Round Line

PRODUCT CODE NA40



CONSTRUCTION

12 strand braid in Polyester

FEATURES AND USE

For the mooring of small boats to Super Yachts. Always smooth, even after prolonged use. Easy to splice.

STANDARD DIAMETERS

From 16 to 44 mm
Other diameters on request

COLOURS



Hemp

Beige

Square Line

PRODUCT CODE NA41



CONSTRUCTION

8 strand braid in Polyester

FEATURES AND USE

Commonly used for the mooring of all types of boats up to Super Yachts, anchoring as well as temporary and long moorings of medium and small boats.

STANDARD DIAMETERS

From 10 to 52 mm
Other diameters on request

COLOURS



Hemp

Beige

Sea King

PRODUCT CODE NA42



CONSTRUCTION

3 strand rope with balanced torsion, double twist construction in Polyester

FEATURES AND USE

This is the best choice for permanent moorings, for mooring on mooring posts and for all types of boats.

STANDARD DIAMETERS

From 3 to 40 mm
Other diameters on request

COLOURS



Hemp

Beige

Mooring line

THE MOORING OF ANY TYPE OF BOAT IS A MATTER OF CRUCIAL IMPORTANCE. IN FACT IT HAS TO GUARANTEE THE SAFETY OF THE CREW, OF THE BOAT AND OF ANY OTHER NEARBY BOAT. AMONG THE WIDE RANGE OF ARMARE PROPOSALS FOR MOORING, IT IS EASY TO FIND THE MOST SUITABLE PRODUCT FOR ANY NEED, FOR FIXED OR FLYING MOORINGS, OR FOR SECURE ANCHORINGS.



Solutions for both sailing as motor boats

A huge range of custom-made mooring ropes, with excellent performance and durability. Special handcrafted finishing and protections, unique custom colours, high breaking load and light weight are the features of this line, that make it suitable for any application, in particular for the mooring of Super Yachts, where extraordinary high loads are required. Some articles are also available in Hemp colour, especially made to be used on classic and vintage boats (more information can be found on the part "Classic Line" of this catalogue).

Available manufactures:

- Splicing on stainless-steel thimble
- Handmade finishing with Cordura® heavy fabric
- Handmade leather finishing
- Splicing with loop of every size
- Possibility of embroideries on every type of protection

All the finishes are available on the complete range of mooring lines.

Types of splicing and protections



Stainless-steel thimble without protection



Loop without protection



Loop with leather protection

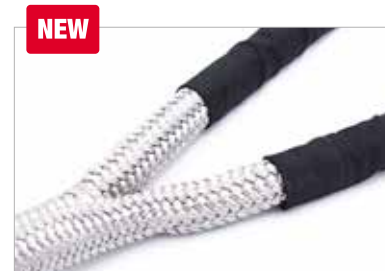

Spliced loop with Cordura® fabric heavy protection

Colours

Available standard colours of the ropes



Available special colours of the ropes



Available leathers protections



Cordura® heavy fabric



Fender Covers

To protect the sides of the boat, a large range of fender covers is available in addition to the mooring lines. Make your choice between many different sizes and colours and give your boat a touch of class and personality with customized covers showing the embroidered name and/or logo of the boat.



Mooring line

Floating ropes

MOORING - BREAKING LOAD AND WEIGHT COMPARATIVE TABLE

Ø	FLOATING		FLOATING NEW		FLOATING	
	SECUR LINE		NOVUS LINE		SQUARE LINE PP	
	N037		NA17C63		NA43	
DIAM	B. L.	WEIGHT	B. L.	WEIGHT	B. L.	WEIGHT
[mm]	[daN]	[g /m]	[daN]	[g /m]	[daN]	[g /m]
3	-	-	-	-	-	-
4	-	-	-	-	-	-
5	-	-	-	-	-	-
6	-	-	-	-	-	-
7	-	-	-	-	-	-
8	-	-	-	-	-	-
9	-	-	-	-	-	-
10	10.000	63,00	-	-	-	-
11	-	-	-	-	-	-
12	12.500	82,00	-	-	1.560	56,00
14	15.000	100,00	6.000	105,00	2.000	78,00
16	18.000	130,00	7.000	120,00	2.500	92,00
18	20.600	180,00	9.000	135,00	3.200	115,00
20	23.000	220,00	10.500	182,00	4.000	160,00
22	-	-	12.700	244,00	5.000	178,00
24	28.000	300,00	14.500	290,00	5.500	214,00
26	-	-	15.800	330,00	-	-
28	34.000	340,00	17.000	350,00	7.000	280,00
30	-	-	19.400	370,00	-	-
32	39.000	400,00	20.800	390,00	9.500	365,00
34	-	-	-	-	-	-
36	45.000	500,00	22.000	505,00	13.000	471,00
38	-	-	-	-	-	-
40	50.000	560,00	25.300	568,00	17.000	525,00
44	55.000	626,00	-	-	19.000	585,00
48	60.000	680,00	-	-	22.500	645,00
52	-	-	-	-	24.000	705,00

NOTE ABOUT BREAKING LOAD AND DIAMETERS The average values shown above are derived from tests taken at Armare laboratory, on properly spliced new ropes, and may change without notice. Other diameters available on request. The static load of the rope must not exceed 20% of breaking load shown in the table. Knots may affect the breaking load of the rope with reductions of up to 60%. The splicing increases the diameter of the rope of about 1.5 times. The use and exposure to weather conditions, depending from the kind of rope and the time of exposure, can reduce the breaking loads of the ropes.

Secur Line

PRODUCT CODE N037



100% SK78 PU COATED TIGHTWEAVE FLOATING DYNEEMA

CONSTRUCTION

Balanced twist 8 strand braid made with 100% Dyneema® SK78 and PU Coating.

FEATURES AND USE

Ideal for emergency anchoring and long mooring from boat to land and as towing line. Made of 100% Dyneema® SK78 it assures high breaking load, lightness, low elongation, almost zero water absorption, high visibility of the rope and high resistance to abrasion and cut.

STANDARD DIAMETERS

From 10 to 48 mm

STANDARD COLOURS



Grey

Hemp

Yellow

Novus Line

PRODUCT CODE NA17C63

NEW



100% SK78 PU COATED TIGHTWEAVE FLOATING

CONSTRUCTION

Double Braid - 100% Dyneema® SK78 core, 100% H.T. Polypropylene cover.

FEATURES AND USE

The latest new rope concept for floatable moorings and towing lines. Novus Line is a new generation rope made with a Dyneema® SK78 braiding core, which assures the 100% of the load and protected and covered by a 12 strands braid in H.T. Polypropylene with UV treatment. The result is an incredible floating rope extremely flexible and easily maneuverable, with high breaking strength, light weight, low water absorption. It assures a good protection from accidental cutting and is spliceable with a right technique.

STANDARD DIAMETERS

From 14 to 40 mm

STANDARD COLOURS

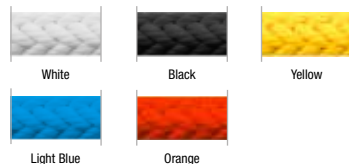

White

Black

Yellow

Light Blue

Orange

Square Line PP

PRODUCT CODE NA43



FLOATING PP MULTIFILAMENT

CONSTRUCTION

8 strand braid in H.T. Polypropylene with UV treatment.

FEATURES AND USE

Multi-use floating line, for long moorings and towing.

STANDARD DIAMETERS

From 12 to 52 mm

STANDARD COLOURS

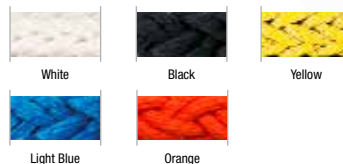

White

Black

Yellow

Light Blue

Orange



Mooring line

Conventional ropes

MOORING - BREAKING LOAD AND WEIGHT COMPARATIVE TABLE

Ø	STORM LINE PLUS		STORM LINE		ROUND LINE		SQUARE LINE		SEA KING	
	NA90_SLP		N020		NA40		NA41		NA42	
DIAM	B. L.	WEIGHT	B. L.	WEIGHT	B. L.	WEIGHT	B. L.	WEIGHT	B. L.	WEIGHT
[mm]	[daN]	[g /m]	[daN]	[g /m]	[daN]	[g /m]	[daN]	[g /m]	[daN]	[g /m]
3	-	-	-	-	-	-	-	-	300	9,00
4	-	-	-	-	-	-	-	-	470	16,00
5	-	-	-	-	-	-	-	-	600	22,00
6	-	-	-	-	-	-	-	-	700	28,00
7	-	-	-	-	-	-	-	-	-	-
8	-	-	2.000	46,00	-	-	-	-	1.270	48,00
9	-	-	-	-	-	-	-	-	-	-
10	-	-	2.650	68,00	-	-	1.600	71,00	1.680	70,00
11	-	-	-	-	-	-	-	-	-	-
12	-	-	3.500	97,00	-	-	2.100	92,00	2.800	103,00
14	-	-	4.200	134,00	-	-	2.900	128,00	3.600	140,00
16	11.500	163,00	4.900	144,00	4.160	170,00	3.500	152,00	4.300	185,00
18	-	-	5.400	188,00	5.018	195,00	4.100	170,00	5.400	230,00
20	18.200	239,00	8.500	288,00	5.460	240,00	4.500	225,00	6.700	290,00
22	24.400	305,00	11.600	365,00	6.045	305,00	5.000	255,00	8.300	320,00
24	30.000	366,00	13.500	441,00	6.890	350,00	5.700	290,00	9.700	437,00
26	37.000	425,00	14.600	510,00	8.099	421,00	6.500	360,00	11.100	500,00
28	45.000	477,00	18.500	575,00	10.465	550,00	8.400	380,00	12.050	565,00
30	52.000	608,00	20.000	640,00	11.648	630,00	9.650	470,00	13.400	650,00
32	61.000	740,00	23.600	890,00	12.350	710,00	10.870	560,00	15.400	740,00
34	70.000	838,00	-	-	-	-	-	-	-	-
36	79.000	937,00	25.500	1.130,00	15.600	850,00	13.700	640,00	19.000	900,00
38	88.000	999,00	-	-	-	-	-	-	-	-
40	99.500	1.062,00	31.000	1.280,00	17.500	1.160,00	15.580	830,00	23.500	1.150,00
44	-	-	36.000	1.470,00	20.000	1.450,00	19.400	1.050,00	-	-
48	-	-	40.800	1.760,00	-	-	23.300	1.200,00	-	-
52	-	-	49.900	2.050,00	-	-	28.100	1.320,00	-	-

NOTE ABOUT BREAKING LOAD AND DIAMETERS The average values shown above are derived from tests taken at Armare laboratory, on properly spliced new ropes, and may change without notice. Other diameters available on request. The static load of the rope must not exceed 20% of breaking load shown in the table. Knots may affect the breaking load of the rope with reductions of up to 60%. The splicing increases the diameter of the rope of about 1.5 times. The use and exposure to weather conditions, depending from the kind of rope and the time of exposure, can reduce the breaking loads of the ropes.

Storm Line Plus

PRODUCT CODE NA90_SLP



100%
SK78

CONSTRUCTION

Balanced twist Dyneema® braided core, Polyester cover.

FEATURES AND USE

It brings a significant improvement to the lives of the crew, ensuring very high breaking load and small diameters, extreme safety and low water absorption. Furthermore, thanks to the core in Dyneema®, the weight is halved if compared to ropes with equal load in Polyester/ Nylon. The choice of Storm Line Plus for the mooring of your boat provides an economic benefit over time, thanks to the extraordinary durability.

STANDARD DIAMETERS

From 16 to 40 mm

STANDARD COLOURS



Black Blue Navy Silver Grey

Storm Line

PRODUCT CODE N020



CONSTRUCTION

Balanced twisted Polyester braided core, Polyester cover.

FEATURES AND USE

Ideal for Super Yachts but also for emergency or long moorings of small and medium sized boats.

STANDARD DIAMETERS

From 8 to 52 mm

STANDARD COLOURS



White Black Blue Navy

SPECIAL COLOURS



Silver Grey Hemp Red Bordeaux English Green

Round Line

PRODUCT CODE NA40



CONSTRUCTION

12 strand braid in Polyester.

FEATURES AND USE

For the mooring of small boats to Super Yachts. Always smooth, even after prolonged use. Easy to splice.

STANDARD DIAMETERS

From 16 to 44 mm

STANDARD COLOURS



White Black Blue Navy

SPECIAL COLOURS

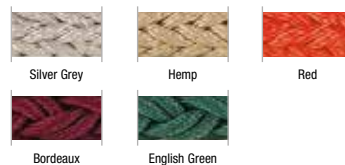

Silver Grey Hemp Red Bordeaux English Green

Square Line

PRODUCT CODE NA41



CONSTRUCTION

8 strand braid in Polyester.

FEATURES AND USE

Commonly used for the mooring of all types of boats up to Super Yachts, anchoring as well as temporary and long moorings of medium and small boats.

STANDARD DIAMETERS

From 10 to 52 mm

STANDARD COLOURS



White Black Blue Navy

SPECIAL COLOURS



Silver Grey Hemp Red Bordeaux English Green

Sea King

PRODUCT CODE NA42



CONSTRUCTION

3 strand rope with balanced torsion, double twist construction in Polyester.

FEATURES AND USE

This is the best choice for permanent moorings, for mooring on mooring posts and for all types of boats.

STANDARD DIAMETERS

From 3 to 40 mm

STANDARD COLOURS



White Black Blue Navy

SPECIAL COLOURS

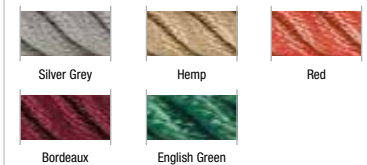

Silver Grey Hemp Red Bordeaux English Green

One Design line

Our champions



Carlo De Paoli / Open Moth Italian Champion
Ph © Renato Tebaldi



Marco Gradoni / Optimist World Champion 2017, 2018 and 2019
Ph © Matias Capizzano



Tullio Picciolini - Giammarco Sardi / 6m Ocean Cat
Ph © Andrea Falcon



Antonio Squizzato / 2.4 Mr
Ph © Fabio Taccola



Benedetta Di Salle - Alessandra Dubbini / 470F
Ph © Sailing Energy



Leopoldo Siroli / O'Pen Bic / World Cup Bronze Medal Winner

ARMARE ONE DESIGN IS A LINE OF INNOVATIVE PRODUCTS, DESIGNED AND TESTED BY HIGH LEVEL ATHLETES AND OLYMPIC TEAMS, TO SATISFY ALL THE NEEDS OF THE MOST DEMANDING CLASSES.

THIS LINE OFFERS PRODUCTS IN ROLLS, WHICH CAN BE USED FOR VARIOUS MANEUVERS ON ONE DESIGN CLASSES, AS WELL AS INDIVIDUAL ROPES AND ARTICLES WHICH ARE SETTLED AND CALIBRATED FOR THE SPECIFIC USE ON BOARD. ALL PRODUCTS ARE CONSTANTLY DEVELOPED IN COOPERATION WITH TOP-LEVEL ATHLETES AND OUR TECHNICAL DEPARTMENT. FOR SOME CLASSES ARMARE PROVIDES COMPLETE FULL KITS THAT COVER THE WHOLE RIG ONBOARD.



Enfant Terrible Sailing Team / J70 2018 European Championship



Gianluigi Ugolini - Maria Giubilei / European Champions U23
Ph © Martina Orsini



Porro - Leoni / 29er World, European and Italian Champions
Ph © Elena Giolai

GAMBERUS 2.0 / GAMBERUS 2.0 PLUS

the best sheet for your Optimist

Two new sheets, one construction

Before being launched on the market, the new sheet Gamberus 2.0 was tested by many different international teams, winners of the World Championship, the European Championship as well as several Italian races.

Thanks to its awesome smoothness and ease of movement, the innovative construction turns Gamberus 2.0 into the best sheet for Optimist.

Gamberus 2.0 / Gamberus 2.0 PLUS

Two versions make the choice even more complete and guarantee the best performance to each type of athlete. Both the sheets differ in terms of elasticity and resistance to abrasion.

In fact, Gamberus 2.0 Plus is constructed with an insert of Black Technora® fiber that guarantees an ideal performance to each sailor, even the most sensitive and technical.

Gamberus 2.0 - Tapered Main Sheet

N73_OPTI_2.0_MAINSHEET
COLOUR Orange Fluo / Yellow

Gamberus 2.0 Plus - Tapered Main Sheet

N73_OPTI_2.OP_MAINSHEET
COLOUR Black / Blue



Armare Official Supplier

Armare Ropes, official supplier to FIV (Italian Sailing Federation) and supporter of the Italian Olympic Team as well as of the AICO National Competitive Team.



- > **UNIQUE GRIP**
- > **OPTIMIZED DIAMETER**
- > **ABSOLUTE LIGHTNESS**



OPTIMIST LINE

Downhaul

PRODUCT CODE N73_OPTI_DOWNHAUL



CONSTRUCTION

Black Dyneema® + Cordura® + Dyneema® SK99 + HPS + PU

FEATURES AND USE

Spliced Downhaul, cut and finished at the exact length, ready to be used.

Outhaul

PRODUCT CODE N73_OPTI_OUTHAUL



CONSTRUCTION

Black Dyneema® + Cordura®

FEATURES AND USE Spliced Outhaul, cut and finished at the exact length, ready to be used.

Complete Halyard System

PRODUCT CODE N73_OPTI_HALYARD



CONSTRUCTION

Protection cover in Black Technora® + Dyneema® + Polyester

FEATURES AND USE

Complete Halyard system composed by spliced ropes, cut at the exact length and finished with an Armare Lash Bobbin, ready to be used.

Single Friction Block

PRODUCT CODE N73_OPTI_SFB



CONSTRUCTION

Dyneema® SK99 + HPS + PU

FEATURES AND USE

Single friction block made with a spliced rope and finished with an Armare Lash Bobbin. Ideal for slight wind conditions.

Double Friction Block

PRODUCT CODE N73_OPTI_DFB



CONSTRUCTION

Dyneema® SK99 + HPS + PU

FEATURES AND USE

Double friction block made with a spliced rope and finished with two Armare Lash Bobbins. Ideal for severe wind conditions.

Strops

PRODUCT CODE NA93C24_20
NA93C24_50

NEW



CONSTRUCTION Braid with core

CORE Dyneema® SK78

COVER Cordura® + Polyester

FEATURES AND USE

Strops for Optimist sail.
Roll length: **20 meters and 50 meters.**

STANDARD DIAMETERS

1,4 mm and 2,5 mm

STANDARD COLOURS

Melange White / Silver Grey
Melange White / Azure

Kit Optimist Strops

PRODUCT CODE N73_OPTI_KITSTROPI



It is composed by:

- n°12 strops 1,4 mm thermocut length 50 cm.
- n°5 strops 2,5 mm thermocut length 60 cm.

CONSTRUCTION

Braid with core in Dyneema® SK78

COVER Cordura® + Polyester

FEATURES AND USE

Strops for Optimist sail.

STANDARD DIAMETERS

1,4 mm and 2,5 mm

STANDARD COLOURS

Melange White / Silver Grey
Melange White / Azure

OPTIMIST LINE

Gamberus Mainsheet

PRODUCT CODE NA71100MEC88



CONSTRUCTION Single Braid in Dyneema® + Polyester

FEATURES AND USE

Light and comfortable handgrip, low water absorption, easy to taper. Ideal to be used as sheet for Optimist. It is sold by roll.

STANDARD DIAMETERS

10 mm

STANDARD COLOUR

Melange Black / Azure

Optimist Halyard

PRODUCT CODE NA00C85_OD



CONSTRUCTION Protection cover in Black Technora® + Dyneema® + Polyester

FEATURES AND USE

Used as halyard for Optimist.

STANDARD DIAMETERS

6 mm

STANDARD COLOURS

Melange Black / White / Orange Fluo

Duck Line

PRODUCT CODE NA63C63



CONSTRUCTION Double Braid Polypropylene with UV treatment

FEATURES AND USE

Floating rope ideal for the towing of Dinghies.

STANDARD DIAMETERS

5 mm

STANDARD COLOURS

Yellow / Red

Gamberus Full Kit Optimist

NEW

PRODUCT CODE N73_OPTI_EVO_FK



A complete kit including very performing ropes to equip your optimist. they are furnished ready-to-use at the required length and where necessary, spliced and finished.

CODE	PRODUCTS
N73_OPTI_2.0_MAINSHEET	GAMBERUS 2.0 - TAPERED MAIN SHEET
N73_OPTI_DOWNHAUL	DOWNHAUL
N73_OPTI_OUTHAUL	OUTHAUL
N73_OPTI_HALYARD	COMPLETE HALYARD SYSTEM
N73_OPTI_SFB	SINGLE FRICTION BLOCK
NA93014MEC24_20	ROLL OFF STROPS mm 1,4 - 20 meters
NA93025MEC24_20	ROLL OFF STROPS mm 2,5 - 20 meters

One Design products

Sold by roll of 100/200 m

Ø [mm]	CODE	PRODUCT	APPLICATION	420	470	2.4 mm	29er	49er	49er FX	BYTE	LASER 4.7	LASER Radial	SONAR	DINGHY 12'	SKUD 18	NACRA 17	FINN	MOTH	OTHER DINGHIES
6,8	NA63070MEC86	ZUMBA	Laser & Byte Mainsheet	<input type="checkbox"/>	<input type="checkbox"/>	<input type="checkbox"/>	<input type="checkbox"/>	<input type="checkbox"/>	<input type="checkbox"/>	<input checked="" type="checkbox"/>	<input checked="" type="checkbox"/>	<input checked="" type="checkbox"/>	<input type="checkbox"/>	<input type="checkbox"/>	<input type="checkbox"/>	<input type="checkbox"/>	<input type="checkbox"/>	<input type="checkbox"/>	<input type="checkbox"/>
5	NA26050MEC86	KUMBA 5	Spi sheet & Gennaker sheet	<input checked="" type="checkbox"/>	<input checked="" type="checkbox"/>	<input type="checkbox"/>	<input type="checkbox"/>	<input checked="" type="checkbox"/>	<input checked="" type="checkbox"/>	<input type="checkbox"/>	<input type="checkbox"/>	<input type="checkbox"/>	<input type="checkbox"/>	<input type="checkbox"/>	<input checked="" type="checkbox"/>	<input checked="" type="checkbox"/>	<input checked="" type="checkbox"/>	<input type="checkbox"/>	<input type="checkbox"/>
6	NA26060MEC86	KUMBA 6	Spi sheet & Gennaker sheet	<input checked="" type="checkbox"/>	<input checked="" type="checkbox"/>	<input type="checkbox"/>	<input type="checkbox"/>	<input checked="" type="checkbox"/>	<input checked="" type="checkbox"/>	<input type="checkbox"/>	<input type="checkbox"/>	<input type="checkbox"/>	<input type="checkbox"/>	<input type="checkbox"/>	<input checked="" type="checkbox"/>	<input checked="" type="checkbox"/>	<input checked="" type="checkbox"/>	<input type="checkbox"/>	<input type="checkbox"/>
7	NA26070MEC86	KUMBA 7	Mainsheet & Jib sheet	<input checked="" type="checkbox"/>	<input checked="" type="checkbox"/>	<input checked="" type="checkbox"/>	<input checked="" type="checkbox"/>	<input checked="" type="checkbox"/>	<input checked="" type="checkbox"/>	<input checked="" type="checkbox"/>	<input type="checkbox"/>	<input type="checkbox"/>	<input checked="" type="checkbox"/>	<input checked="" type="checkbox"/>	<input checked="" type="checkbox"/>	<input checked="" type="checkbox"/>	<input checked="" type="checkbox"/>	<input checked="" type="checkbox"/>	<input type="checkbox"/>
3,5	NA58035MTC86	HAND LINE	Cunningham & Vang Skiff circuit	<input type="checkbox"/>	<input type="checkbox"/>	<input type="checkbox"/>	<input checked="" type="checkbox"/>	<input checked="" type="checkbox"/>	<input type="checkbox"/>	<input type="checkbox"/>	<input type="checkbox"/>	<input type="checkbox"/>	<input type="checkbox"/>	<input type="checkbox"/>	<input type="checkbox"/>	<input checked="" type="checkbox"/>	<input checked="" type="checkbox"/>	<input checked="" type="checkbox"/>	<input type="checkbox"/>
3	NA63030SOC17_S	LORENZ LINE NEW	Running Rigging	<input type="checkbox"/>	<input type="checkbox"/>	<input type="checkbox"/>	<input type="checkbox"/>	<input checked="" type="checkbox"/>	<input checked="" type="checkbox"/>	<input type="checkbox"/>	<input type="checkbox"/>	<input type="checkbox"/>	<input type="checkbox"/>	<input type="checkbox"/>	<input type="checkbox"/>	<input type="checkbox"/>	<input type="checkbox"/>	<input checked="" type="checkbox"/>	<input type="checkbox"/>
4	NA63040SOC17_S	LORENZ LINE NEW	Running Rigging	<input type="checkbox"/>	<input type="checkbox"/>	<input type="checkbox"/>	<input type="checkbox"/>	<input checked="" type="checkbox"/>	<input checked="" type="checkbox"/>	<input type="checkbox"/>	<input type="checkbox"/>	<input type="checkbox"/>	<input type="checkbox"/>	<input type="checkbox"/>	<input type="checkbox"/>	<input type="checkbox"/>	<input type="checkbox"/>	<input checked="" type="checkbox"/>	<input type="checkbox"/>
5	NA63050SOC17_S	LORENZ LINE NEW	Running Rigging	<input type="checkbox"/>	<input type="checkbox"/>	<input type="checkbox"/>	<input type="checkbox"/>	<input checked="" type="checkbox"/>	<input checked="" type="checkbox"/>	<input type="checkbox"/>	<input type="checkbox"/>	<input type="checkbox"/>	<input type="checkbox"/>	<input type="checkbox"/>	<input type="checkbox"/>	<input type="checkbox"/>	<input type="checkbox"/>	<input checked="" type="checkbox"/>	<input type="checkbox"/>
6	NA63060SOC17_S	LORENZ LINE NEW	Running Rigging	<input type="checkbox"/>	<input type="checkbox"/>	<input type="checkbox"/>	<input type="checkbox"/>	<input checked="" type="checkbox"/>	<input checked="" type="checkbox"/>	<input type="checkbox"/>	<input type="checkbox"/>	<input type="checkbox"/>	<input type="checkbox"/>	<input type="checkbox"/>	<input type="checkbox"/>	<input type="checkbox"/>	<input type="checkbox"/>	<input checked="" type="checkbox"/>	<input type="checkbox"/>
5	NA63050MEC63	DUCK LINE	Floating towing line	<input checked="" type="checkbox"/>	<input checked="" type="checkbox"/>	<input checked="" type="checkbox"/>	<input checked="" type="checkbox"/>	<input checked="" type="checkbox"/>	<input checked="" type="checkbox"/>	<input checked="" type="checkbox"/>	<input checked="" type="checkbox"/>	<input checked="" type="checkbox"/>	<input checked="" type="checkbox"/>	<input checked="" type="checkbox"/>	<input checked="" type="checkbox"/>	<input checked="" type="checkbox"/>	<input checked="" type="checkbox"/>	<input checked="" type="checkbox"/>	<input type="checkbox"/>
8	NA63080MEC63	DUCK LINE	Floating towing line	<input checked="" type="checkbox"/>	<input checked="" type="checkbox"/>	<input checked="" type="checkbox"/>	<input checked="" type="checkbox"/>	<input checked="" type="checkbox"/>	<input checked="" type="checkbox"/>	<input checked="" type="checkbox"/>	<input checked="" type="checkbox"/>	<input checked="" type="checkbox"/>	<input checked="" type="checkbox"/>	<input checked="" type="checkbox"/>	<input checked="" type="checkbox"/>	<input checked="" type="checkbox"/>	<input checked="" type="checkbox"/>	<input checked="" type="checkbox"/>	<input type="checkbox"/>
4,8	NA77050SNC71	STOP 1	Main - Jib - Spi - Gk Halyard	<input checked="" type="checkbox"/>	<input checked="" type="checkbox"/>	<input checked="" type="checkbox"/>	<input checked="" type="checkbox"/>	<input checked="" type="checkbox"/>	<input checked="" type="checkbox"/>	<input type="checkbox"/>	<input type="checkbox"/>	<input type="checkbox"/>	<input checked="" type="checkbox"/>	<input type="checkbox"/>	<input checked="" type="checkbox"/>	<input type="checkbox"/>	<input type="checkbox"/>	<input type="checkbox"/>	<input type="checkbox"/>
4,6	NA77050SNC69	STOP 2	Main - Jib - Spi - Gk Halyard	<input checked="" type="checkbox"/>	<input checked="" type="checkbox"/>	<input checked="" type="checkbox"/>	<input checked="" type="checkbox"/>	<input checked="" type="checkbox"/>	<input checked="" type="checkbox"/>	<input type="checkbox"/>	<input type="checkbox"/>	<input type="checkbox"/>	<input checked="" type="checkbox"/>	<input type="checkbox"/>	<input checked="" type="checkbox"/>	<input type="checkbox"/>	<input type="checkbox"/>	<input type="checkbox"/>	<input type="checkbox"/>
4,8	NA59050SNC24	STOP 3	Main - Jib - Spi - Gk Halyard	<input type="checkbox"/>	<input checked="" type="checkbox"/>	<input type="checkbox"/>	<input checked="" type="checkbox"/>	<input type="checkbox"/>	<input checked="" type="checkbox"/>	<input type="checkbox"/>	<input type="checkbox"/>	<input type="checkbox"/>	<input type="checkbox"/>	<input type="checkbox"/>	<input type="checkbox"/>	<input type="checkbox"/>	<input type="checkbox"/>	<input type="checkbox"/>	<input type="checkbox"/>
4,6	NA59045SNC51	STOP 4	Main - Jib - Spi - Gk Halyard	<input checked="" type="checkbox"/>	<input checked="" type="checkbox"/>	<input checked="" type="checkbox"/>	<input checked="" type="checkbox"/>	<input checked="" type="checkbox"/>	<input checked="" type="checkbox"/>	<input type="checkbox"/>	<input type="checkbox"/>	<input type="checkbox"/>	<input checked="" type="checkbox"/>	<input type="checkbox"/>	<input checked="" type="checkbox"/>	<input type="checkbox"/>	<input type="checkbox"/>	<input type="checkbox"/>	<input type="checkbox"/>
3	NA77030SNC24	STOP 5	470 Spi- Halyard	<input type="checkbox"/>	<input checked="" type="checkbox"/>	<input type="checkbox"/>	<input type="checkbox"/>	<input type="checkbox"/>	<input type="checkbox"/>	<input type="checkbox"/>	<input type="checkbox"/>	<input type="checkbox"/>	<input type="checkbox"/>	<input type="checkbox"/>	<input type="checkbox"/>	<input type="checkbox"/>	<input type="checkbox"/>	<input type="checkbox"/>	<input type="checkbox"/>
3	NA59030SNC24	STOP 6	470 Spi - Halyard & Running Line	<input type="checkbox"/>	<input checked="" type="checkbox"/>	<input type="checkbox"/>	<input type="checkbox"/>	<input type="checkbox"/>	<input type="checkbox"/>	<input type="checkbox"/>	<input type="checkbox"/>	<input type="checkbox"/>	<input type="checkbox"/>	<input type="checkbox"/>	<input type="checkbox"/>	<input type="checkbox"/>	<input type="checkbox"/>	<input type="checkbox"/>	<input type="checkbox"/>
2,8	NA54028MTC00	RUN LINE	Running Rigging	<input checked="" type="checkbox"/>	<input checked="" type="checkbox"/>	<input checked="" type="checkbox"/>	<input checked="" type="checkbox"/>	<input checked="" type="checkbox"/>	<input checked="" type="checkbox"/>	<input checked="" type="checkbox"/>	<input checked="" type="checkbox"/>	<input checked="" type="checkbox"/>	<input checked="" type="checkbox"/>	<input checked="" type="checkbox"/>	<input checked="" type="checkbox"/>	<input checked="" type="checkbox"/>	<input checked="" type="checkbox"/>	<input checked="" type="checkbox"/>	<input type="checkbox"/>
3,8	NA54038MTC00	RUN LINE	Running Rigging	<input checked="" type="checkbox"/>	<input checked="" type="checkbox"/>	<input checked="" type="checkbox"/>	<input checked="" type="checkbox"/>	<input checked="" type="checkbox"/>	<input checked="" type="checkbox"/>	<input checked="" type="checkbox"/>	<input checked="" type="checkbox"/>	<input checked="" type="checkbox"/>	<input checked="" type="checkbox"/>	<input checked="" type="checkbox"/>	<input checked="" type="checkbox"/>	<input checked="" type="checkbox"/>	<input checked="" type="checkbox"/>	<input checked="" type="checkbox"/>	<input type="checkbox"/>
5,5	NA54055MTC00	RUN LINE	Running Rigging	<input checked="" type="checkbox"/>	<input checked="" type="checkbox"/>	<input checked="" type="checkbox"/>	<input checked="" type="checkbox"/>	<input checked="" type="checkbox"/>	<input checked="" type="checkbox"/>	<input checked="" type="checkbox"/>	<input checked="" type="checkbox"/>	<input checked="" type="checkbox"/>	<input checked="" type="checkbox"/>	<input checked="" type="checkbox"/>	<input checked="" type="checkbox"/>	<input checked="" type="checkbox"/>	<input checked="" type="checkbox"/>	<input checked="" type="checkbox"/>	<input type="checkbox"/>
5,5	NA73055MEC00	RUN COLOR NEW	Running Rigging	<input checked="" type="checkbox"/>	<input checked="" type="checkbox"/>	<input checked="" type="checkbox"/>	<input checked="" type="checkbox"/>	<input checked="" type="checkbox"/>	<input checked="" type="checkbox"/>	<input checked="" type="checkbox"/>	<input checked="" type="checkbox"/>	<input checked="" type="checkbox"/>	<input checked="" type="checkbox"/>	<input checked="" type="checkbox"/>	<input checked="" type="checkbox"/>	<input checked="" type="checkbox"/>	<input checked="" type="checkbox"/>	<input checked="" type="checkbox"/>	<input type="checkbox"/>
6	NA34060MEC00	COLIBRÌ NEW	Sheet ideal for dinghies	<input type="checkbox"/>	<input type="checkbox"/>	<input type="checkbox"/>	<input type="checkbox"/>	<input type="checkbox"/>	<input type="checkbox"/>	<input type="checkbox"/>	<input type="checkbox"/>	<input type="checkbox"/>	<input type="checkbox"/>	<input type="checkbox"/>	<input type="checkbox"/>	<input type="checkbox"/>	<input type="checkbox"/>	<input type="checkbox"/>	<input checked="" type="checkbox"/>
8	NA34080MEC00	COLIBRÌ NEW	Sheet ideal for dinghies	<input type="checkbox"/>	<input type="checkbox"/>	<input type="checkbox"/>	<input type="checkbox"/>	<input type="checkbox"/>	<input type="checkbox"/>	<input type="checkbox"/>	<input type="checkbox"/>	<input type="checkbox"/>	<input type="checkbox"/>	<input type="checkbox"/>	<input type="checkbox"/>	<input type="checkbox"/>	<input type="checkbox"/>	<input type="checkbox"/>	<input checked="" type="checkbox"/>

Zumba

PRODUCT CODE NA63C86



CONSTRUCTION

Double braid with special light core

COVER Black Technora® + Polyester

FEATURES AND USE

Ideal as main sheet for Laser and Byte. Light and comfortable hand grip, low water absorption. It is sold by roll and also as finished sheet.

STANDARD DIAMETER

6,8 mm

STANDARD COLOURS

Melange Black / Red

Kumba 5 - 6 - 7

PRODUCT CODE NA26C86



CONSTRUCTION

Double braid

CORE Dyneema® SK78 + PU

COVER Black Technora® + Polyester

FEATURES AND USE

Suggested as mainsheet and jibsheet.

STANDARD DIAMETER

K5 5 mm

K6 6 mm

K7 7 mm

STANDARD COLOURS

K5 Melange Black / Azure

K6 Melange Black / Yellow

K7 Melange Black / Orange Fluo

or Melange Black / Green Fluo

Hand Line

PRODUCT CODE NA58C86



CONSTRUCTION Double braid

CORE Dyneema® SK78 + PU

COVER Black Technora® + Polyester

FEATURES AND USE

Good handling.

Ideal for running rigging, and cunningham and vang circuit line.

STANDARD DIAMETER

3,5 mm

STANDARD COLOURS

Melange Black / Red
Melange Black / Azure
Melange Black / Yellow

Lorenz Line

PRODUCT CODE NA63C17_S

NEW



CONSTRUCTION Braid 100% Dyneema® SK78 with Shield treatment and unidirectional core.

FEATURES AND USE

Excellent resistance to abrasion and bending, low elongation, good handling. Ideal for running rigging.

STANDARD DIAMETER

3, 4, 5, 6 mm

STANDARD COLOURS

Silver Grey

Duck Line

PRODUCT CODE NA63C63



CONSTRUCTION

Double braid in Polypropylene HT with UV treatment

FEATURES AND USE

Floating rope ideal for the towing of Dinghies.

STANDARD DIAMETER

5 and 8 mm

STANDARD COLOURS

Yellow / Red

CIME ELASTICHE

Dinghy Elastic

PRODUCT CODE T07



CONSTRUCTION

Elastic braid with reinforced cover

FEATURES AND USE

Special for dinghies, thanks to the high durability cover.

STANDARD DIAMETER

From 3 to 8 mm, in rolls of 100 m

Ø	CODE	STANDARD COLOURS	W	L
[mm]			[g/m]	[m]
3	T07030_N	Black	0,83	100
3	T07030_R	Black / Red	0,83	100
4	T07040_B	Black / Blue	1,38	100
5	T07050_G	Black / Yellow	2,20	100
6	T07060_V	Black / Green	3,10	100
8	T07080_V	Black / Green	4,87	100

DynElastic

PRODUCT CODE T07_DYN

NEW



CONSTRUCTION

Elastic braid with a special braided cover in Dyneema®.

FEATURES AND USE

The Dyneema® cover makes this braid very resistant both to abrasion and to repeated micro-movements on the same point and thanks to its features it limits the over-elongation of the braid itself. Excellent UV resistance. It has been developed thinking about the intense use on catamarans, skiffs and other new concept boats.

STANDARD DIAMETER

From 3 to 8 mm in rolls of 100 m

STANDARD COLOURS

White - Pure Black / Yellow

Ø	WEIGHT	ROLL LENGTH
[mm]	[g/m]	[m]
3	6,10	100
4	12,9	100
5	16,8	100
6	26,2	100
7	36,7	100
8	48,0	100

Stop 1

PRODUCT CODE NA77C71



CONSTRUCTION Double Braid

CORE Dyneema® SK78 HPS + PU

COVER Polyester

FEATURES AND USE

It is used as main sheet, jib sheet, spinnaker and gennaker by sailing schools. Easy to taper.

STANDARD DIAMETER 4,8 mm

STANDARD COLOURS

Snake Black / Green
Snake Black / Orange

Stop 2

PRODUCT CODE NA77C69



CONSTRUCTION Double Braid

CORE Dyneema® SK78 HPS + PU

COVER Kevlar® + Polyester

FEATURES AND USE

The best solution for the sliding of the halyard on the cleat of the sail under load. It is suggested as main halyard, jib, spinnaker and gennaker for the first approach to the race. Easy to taper.

STANDARD DIAMETER 4,6 mm

STANDARD COLOURS

Melange Kevlar® / Green
Melange Kevlar® / Orange Fluo

Stop 3

PRODUCT CODE NA59C24



CONSTRUCTION Double Braid

CORE Dyneema® SK99 HPS + PU

COVER Cordura® + Polyester

FEATURES AND USE

Great locking on the cleat, with high breaking load and low elongation. Recommended as main halyard, jib, spinnaker and gennaker for sailors. Easy to taper.

STANDARD DIAMETER 4,8 mm

STANDARD COLOURS

Melange White / Green
Melange White / Orange Fluo

Stop 4

PRODUCT CODE NA59C51



CONSTRUCTION Double Braid

CORE Dyneema® SK99 HPS + PU

COVER Black Technora® + Cordura® + Polyester

FEATURES AND USE

Excellent grip and abrasion resistance, low elongation and high braking load. Recommended as main halyard, jib, spinnaker and gennaker for professional sailors. Easy to taper.

STANDARD DIAMETER 4,6 mm

STANDARD COLOURS

Melange Black / White / Yellow
Melange Black / White / Orange Fluo
Melange Black / White / Azure

Stop 5

PRODUCT CODE NA77C24



CONSTRUCTION Double Braid

CORE Dyneema® SK99 HPS + PU

COVER Cordura® + Polyester

FEATURES AND USE

Ideal to be used as spinnaker sheet for 470. Easy to taper.

STANDARD DIAMETER 3 mm

STANDARD COLOURS

Melange White / Black

Stop 6

PRODUCT CODE NA59C24



CONSTRUCTION Double Braid

CORE Dyneema® SK99 HPS + PU

COVER Black Technora® + Cordura® + Polyester

FEATURES AND USE

Optimal sheet and running line. High grip on the cleat, reduced elongation and excellent resistance to abrasion. Easy to taper.

STANDARD DIAMETER 3 mm

STANDARD COLOURS

Melange Black / White / Azure

Run Line

PRODUCT CODE NA54C00



CONSTRUCTION

12 plait with Black Dyneema® + Cordura®

FEATURES AND USE

Used for general running rigging.

STANDARD DIAMETER

2,8, - 3,8 - 5,5 mm

STANDARD COLOURS

Melange Black / White

Run Color

PRODUCT CODE NA73C00

NEW



CONSTRUCTION

12 plait with Cordura® + HMPE

FEATURES AND USE

Used for general running rigging.

STANDARD DIAMETER

5,5 mm.

STANDARD COLOURS

Melange White / Green
Melange White / Azure

Colibrì

PRODUCT CODE NA34C00

NEW



CONSTRUCTION

Single braid with Polypropylene + Cordura® + Polyester

FEATURES AND USE

Light and flexible. Sheet ideal for Dinghies.

STANDARD DIAMETER

6 and 8 mm

STANDARD COLOURS

Melange White / Red
Melange White / Yellow
Melange White / Azure

Soft Braid

Seven different ropes, designed to maintain an excellent grip. They are lightweight, flexible, easy sliding and don't create loops and twists. These lines are specifically designed to be used on monotypes and for the realization of closed circuits for furling lines.

Armare Super Shape

Soft Braid 5, 6 and 7 are made with the special Super Shape construction, which doesn't deform even after repeated and continuous running on blocks. Keeping a perfect roundness, the rope works better on the V groove of the pulley, preventing slippage due to the "triangulation" of the sheet.

SOFT BRAID ROPES - BREAKING LOAD AND WEIGHT COMPARATIVE TABLE

Ø	SOFT BRAID 1		SOFT BRAID 2		SOFT BRAID 3		SOFT BRAID 4		SUPER SHAPE				SOFT BRAID 7	
	B. L.	WEIGHT	B. L.	WEIGHT	B. L.	WEIGHT	B. L.	WEIGHT	B. L.	WEIGHT	B. L.	WEIGHT	B. L.	WEIGHT
[mm]	[daN]	[g /m]	[daN]	[g /m]	[daN]	[g /m]	[daN]	[g /m]	[daN]	[g /m]	[daN]	[g /m]	[daN]	[g /m]
4	280	15,00	280	14,60	430	14,90	430	14,50	-	-	-	-	-	-
5	420	25,00	420	24,30	690	24,50	690	23,80	-	-	-	-	-	-
6	760	29,00	760	28,10	1.000	28,80	1.000	27,90	800	30,20	800	31,10	800	30,80
7	1.100	37,00	1.100	35,90	1.450	36,60	1.450	35,50	1.100	38,40	1.100	39,60	1.100	39,20
8	1.550	48,00	1.550	46,60	2.100	48,80	2.100	47,30	1.530	51,20	1.530	52,80	1.530	52,20
9	2.100	61,00	2.100	59,20	3.000	60,60	3.000	58,80	2.300	63,60	2.300	65,50	2.300	64,90
10	2.450	73,00	2.450	70,80	4.000	72,50	4.000	70,30	3.230	76,10	3.230	78,40	3.230	77,60
11	3.300	86,50	3.300	83,90	5.000	85,70	5.000	83,10	4.400	90,00	4.400	92,70	4.400	91,80

NOTE ABOUT BREAKING LOAD AND DIAMETERS The average values shown above are derived from tests taken at Armare laboratory, on properly spliced new ropes, and may change without notice. Other diameters available on request. The static load of the rope must not exceed 20% of breaking load shown in the table. Knots may affect the breaking load of the rope with reductions of up to 60%. The splicing increases the diameter of the rope of about 1.5 times. The use and exposure to weather conditions, depending from the kind of rope and the time of exposure, can reduce the breaking loads of the ropes.

Soft Braid 1

PET GRIP

PRODUCT CODE NA63C81



COVER PET grip

CONSTRUCTION Double braid

CORE Polypropylene Braid

FEATURES AND USE Good quality cover, light core with low breaking load and medium elongation. Suggested to be used as closed circuit on furlers.

STANDARD DIAMETERS From 4 to 11 mm

STRETCH AT 30% B. L. 8,00%

STRETCH AT B. L. 15,00%

COLOURS



Soft Braid 2

PET GRIP + DYN

PRODUCT CODE NA63C82



COVER PET grip + Dyneema®

CONSTRUCTION Double braid

CORE Polypropylene Braid

FEATURES AND USE Sliding and abrasion resistant cover, light weight core with low breaking load and average elongation. Aimed at general use, but with frequent runnings.

STANDARD DIAMETERS From 4 to 11 mm

STRETCH AT 30% B. L. 8,00%

STRETCH AT B. L. 15,00%

COLOURS



SUPER SHAPE

Soft Braid 3

PET GRIP + DYN
PRODUCT CODE NA57C82



100%
SK78

COVER PET grip + Dyneema®
CONSTRUCTION Double braid
CORE 12 strand braid made with Dyneema® SK78

FEATURES AND USE Sliding and abrasion resistant cover, good breaking load and low elongation core. Destined to sheets of frequent running.

STANDARD DIAMETERS From 4 to 11 mm
STRETCH AT 30% B. L. 3,10%
STRETCH AT B. L. 3,70%

COLOURS



Soft Braid 4

PET GRIP + DYN + KEV
PRODUCT CODE NA57C83



100%
SK78

COVER PET grip + Dyneema® + Kevlar®
CONSTRUCTION Double braid
CORE 12 strand braid, made with Dyneema® SK78

FEATURES AND USE Sliding cover with excellent resistance to quick surge; optimal duration against abrasions, thanks to the Kevlar® fiber. Low elongation core with good breaking load. Destined to sheets with frequent and fast running.

STANDARD DIAMETERS From 4 to 11 mm
STRETCH AT 30% B. L. 3,10%
STRETCH AT B. L. 3,70%

COLOURS



Soft Braid 5

PET GRIP + DYN
PRODUCT CODE NA26C82



100%
SK78

PU COATED TREATMENT
 SUPER SHAPE

COVER PET grip + Dyneema®
CONSTRUCTION Double braid
CORE 12 strand braid, made with Dyneema® SK78, impregnated with PU coating and anti-flattening insert.

FEATURES AND USE Sliding cover and resistant to abrasions. Super Shape core with anti-flattening insert. For sheets which are designed to perfectly work on winches and blocks and do not create loops and kinks.

STANDARD DIAMETERS From 6 to 11 mm
STRETCH AT 30% B. L. 2,70%
STRETCH AT B. L. 3,40%

COLOURS



Soft Braid 6

PET GRIP + KEV
PRODUCT CODE NA26C84



100%
SK78

PU COATED TREATMENT
 SUPER SHAPE

COVER PET grip + Kevlar®
CONSTRUCTION Double braid
CORE 12 strand braid, made with Dyneema® SK78, impregnated with PU coating and anti-flattening insert.

FEATURES AND USE The cover is very resistant to temperature abrasions. Super Shape core with anti-flattening insert. For sheets which are designed to perfectly work on winches and blocks and suffer from high temperature wear and tear, reached during fast surges. It does not create loops and kinks.

STANDARD DIAMETERS From 6 to 11 mm
STRETCH AT 30% B. L. 2,70%
STRETCH AT B. L. 3,40%

COLOURS



Soft Braid 7

PET GRIP + DYN+ KEV
PRODUCT CODE NA26C83



100%
SK78

PU COATED TREATMENT
 SUPER SHAPE

COVER PET grip + Dyneema® + Kevlar®
CONSTRUCTION Double braid
CORE 12 strand braid, made with Dyneema® SK78, impregnated with PU coating and anti-flattening insert.

FEATURES AND USE The cover is very resistant to temperature abrasions. Super Shape core with anti-flattening insert. For sheets which are designed to perfectly work on winches and blocks and suffer from wear and tear due to numerous maneuvers. It does not create loops and kinks.

STANDARD DIAMETERS From 6 to 11 mm
STRETCH AT 30% B. L. 2,70%
STRETCH AT B. L. 3,40%

COLOURS



Rigging line

THE RIGGING LINE PRODUCTS MEET THE NEEDS OF THOSE WHO, FOR WORK OR FOR PASSION, DEVELOP RIGGING APPLICATIONS AND OPTIMISATION IN THE RIGGINGS, FINDING QUALITY ITEMS AND AVANT-GARDE PROPOSALS, WITH A WIDE RANGE OF SIZES, FINISHING AND COLOURS.

Protection covers

Armare has created a new range of Protection Covers for technical ropes. The fibers used to produce them have the highest thermic resistance, with a melting point up to 650 °C and an excellent mechanical abrasion resistance. These products show the highest level of performance and an extreme traction resistance.

USE: Protection Covers are ideal to protect the critical points where the ropes run at high speed, with continuous friction and heavy loading, i.e. to defend the exit points of halyards at the top of masts and on stoppers, to protect sheets and tackles on winches and all the running rigging subject to high stress.

The diameter must be read as diameter of the finished rope when the core is inserted.

Protection cover

PRODUCT CODE NA00

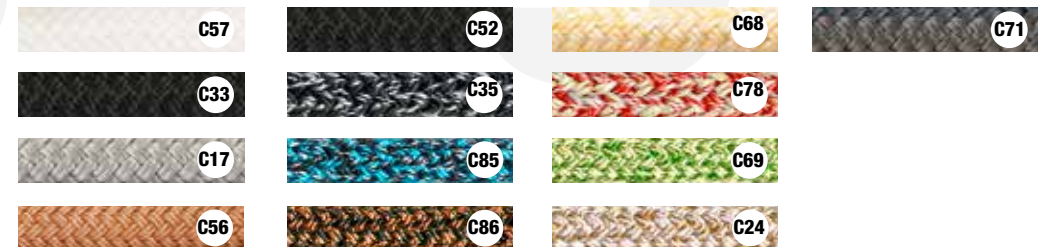

Covers Composition

C57 - DYN WHITE NATURAL	Cover in Dyneema® White Natural
C33 - DYN PURE BLACK PU COATED	Cover in Dyneema® Pure Black + PU
C17 - DYN PU COATED SILVER GREY	Cover in Dyneema® + PU Silver Grey
C56 - PBO	Cover in PBO-Zylon®
C52 - BTEC	Cover in Black Technora®
C35 - BTEC+DYN	Cover in Black Technora® + Dyneema®
C85 - BTEC+DYN+PET	Cover in Black Technora® + Dyneema® + Polyester
C86 - BTEC+PET	Cover in Black Technora® + Polyester
C68 - KEV+DYN	Cover in Kevlar® + Dyneema®
C78 - KEV+DYN+PET	Cover in Kevlar® + Dyneema® + Polyester
C69 - KEV+PET	Cover in Kevlar® + Polyester
C24 - CRD+PET	Cover in Cordura® + Polyester
C71 - PET	Cover in Polyester

Supercable

The special double braid construction with Dyneema® cover provides: minimum elongation, high tensile strength, low weight, maximum cable flexibility, easy splicing and excellent durability. This cable is particularly suitable for the production of runners, forestays, removable forestay, backstay, structural strops, bobstay and the standing rigging of small boats. It also finds wide use on life lines, replacing the steel wire ropes. Supercable 78 and 99 differ in terms of breaking load and lightness. Indeed Supercable 99 guarantees higher performance and lighter weight compared to the ratio between diameter and breaking load.



Supercable 99

PRODUCT CODE N042_99



CONSTRUCTION Double braid
CORE Dyneema® SK99 + HPS + PU
COVER Dyneema® SK78 + PU
COLOUR Grey, black on order

DIAMETER	BREAKING LOAD	WEIGHT
[mm]	[daN]	[g /m]
4	1.444	12,00
5	2.800	19,00
6	4.282	28,00
7	6.200	40,00
8	8.080	45,00
9	9.836	54,00
10	12.446	71,00
11	14.680	83,00
12	15.550	92,00
13	17.300	114,00
14	18.220	140,00

Supercable 78

PRODUCT CODE N042



CONSTRUCTION Double braid
CORE Dyneema® SK78 + HPS + PU
COVER Dyneema® SK78 + PU
COLOUR Grey, black on order

DIAMETER	BREAKING LOAD	WEIGHT
[mm]	[daN]	[g /m]
4	1.155	12,00
5	2.250	19,00
6	3.087	28,00
7	4.995	40,00
8	6.400	45,00
9	8.550	54,00
10	9.716	71,00
11	11.600	83,00
12	14.500	92,00
13	16.000	114,00
14	17.780	140,00

Lumina Life Line

NEW

PRODUCT CODE N042C48

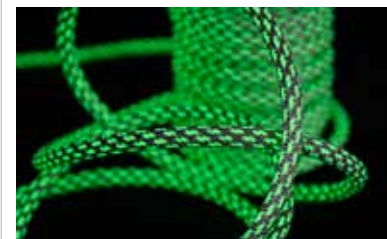

The luminescence inserts make the life line visible even at night, improving safety and making easier the movements on the deck during night-time navigation. Thanks to its construction it is simple to splice and to be settle on board, with an elegant clear and effective result. Moreover, its durability and reliability are guaranteed from several tests on racing and cruising boats.

FEATURES Visible in the dark, light, good abrasion resistance, high breaking load, low elongation.

CONSTRUCTION Double braid

CORE 12 plait with 100% Dyneema® SK99 impregnated with polyurethane coating and special heat treatment HPS.

COVER Dyneema® SK78 + PU coated

COLOUR Black or Silver Grey colour with luminescence inserts

DIAMETER	BREAKING LOAD	WEIGHT
[mm]	[daN]	[g /m]
4	1.444	12,00
5	2.500	20,00
6	3.300	28,00

Zero Twist Cable

PRODUCT CODE VA55

100%
VECTRAN

PU COATED
POLYESTER

Characterized by a particular rigidity, thanks to the special anti-torsion treatment, this cable is designed to be used in the luff of the sails or as a means of torsion transmission in a furling system for spherical sails. The low stretch and the high breaking load make it ideal for the replacement of the double cable into the luff of Code Zero.

Available both in roll and spliced.

CONSTRUCTION Double Braid. Vectran® HS core, Polyester cover with anti torsion treatment

DIAMETER	BREAKING LOAD	WEIGHT
[mm]	[daN]	[g /m]
6	1.100	36,92
7	1.800	45,95
9	3.500	72,75
11	5.500	98,60
13	9.000	136,84
16	14.000	204,90
18	16.800	271,14



DynElastic

PRODUCT CODE T07_DYN

NEW



FEATURES AND US

The Dyneema® cover makes this braid very resistant both to abrasion and to repeated micro-movements on the same point and thanks to its features it limits the over-elongation of the braid itself. Excellent UV resistance. It has been developed thinking about the intense use on catamarans, skiffs and other new concept boats.

CONSTRUCTION

Elastic braid with a special braided cover in Dyneema®.

STANDARD DIAMETER From 3 to 8 mm

COLOURS White - Pure Black / Yellow

Ø	WEIGHT	ROLL LENGTH
[mm]	[g /m]	[m]
3	6,10	100
4	12,9	100
5	16,8	100
6	26,2	100
7	36,7	100
8	48,0	100

Lazy Line

PRODUCT CODE N030



Soft braid, with the right level of compactness to resist to abrasion; always round and balanced, it is easy to splice. Coupled with Lash Bobbin, it makes the construction of Lazy Jack easy. The result is a look which is both technical and elegant.

COLOURS White, Silver Grey, Anthracite and Hemp (other colours on request)

Ø	B.L.	WEIGHT	LENGTH
[mm]	[daN]	[g /m]	[m]
5	400	18,00	100
6	500	21,00	100
7	600	26,00	100
8	700	30,00	100

Dyneema® Light Shackle

PRODUCT CODE N203 (STANDARD SHACKLE) - N204 (BLOCK SHACKLE)

100% SK78



They can be used to substitute any opening metal hook, guaranteeing safety, resistance and a considerable weight reduction (about 6 times less). Their lightness and the construction with textile fibers help to prevent damage to people due to accidental impacts and to protect the boat surface as well as the mast. What's more, they don't squeak. **CONSTRUCTION** The textile Light Shackles are made entirely of Dyneema® SK78, without metal parts.

STANDARD SHACKLE	MAX WORKING LOAD	WEIGHT	LENGTH
	[daN]	[g/pc]	[mm]
LS 5	1.250	15	60
LS 8	2.000	23	70
LS 12	3.000	30	80
LS 20	5.000	70	90
LS 24	7.000	90	100

BLOCK SHACKLE	MAX WORKING LOAD	WEIGHT	LENGTH
	[daN]	[g/pc]	[mm]
LS 5B	1.250	17	90
LS 8B	2.000	25	105
LS 12B	3.000	35	125
LS 20B	5.000	77	135
LS 24B	7.000	98	150

Unidir Loop

100% SK99 100% SK78 PU COATED TREATMENT

Designed for replacing steel shackles and all the steel links on-board, these loops have higher specifications as they are built with unidirectional winding yarns. Dyneema® SK99 fiber is used for the core, while Dyneema® SK78 is used to produce the protection braid treated with a special anti-abrasion coating too. These products guarantee the best ratio diameter/breaking strength available on the market; they can be used in linear and double (basket) configuration as well as with a T-Bone. Warning: The use in different configurations affects the breaking load. Further sizes are available on request.

CONSTRUCTION Multifilament and unidirectional winding yarns

CORE Unidirectional Dyneema® SK99

COVER Dyneema® SK78 treated with a special anti-abrasion coating



CODE	LENGTH	LINEAR B.L.	DIAMETER
	[mm]	[daN]	[mm]
N202UDLOOP 2.2-150	150	2.200	6
N202UDLOOP 2.2-200	200	2.200	6
N202UDLOOP 3.0-150	150	3.000	7
N202UDLOOP 3.0-200	200	3.000	7
N202UDLOOP 3.0-250	250	3.000	7
N202UDLOOP 5.0-100	100	5.000	9
N202UDLOOP 5.0-150	150	5.000	9
N202UDLOOP 5.0-200	200	5.000	9
N202UDLOOP 5.0-250	250	5.000	9
N202UDLOOP 6.0-250	250	6.000	10
N202UDLOOP 8.0-150	150	8.000	12
N202UDLOOP 8.0-200	200	8.000	12
N202UDLOOP 8.0-250	250	8.000	12
N202UDLOOP 10.0-150	150	10.000	13
N202UDLOOP 10.0-200	200	10.000	13
N202UDLOOP 10.0-250	250	10.000	13
N202UDLOOP 10.0-700	700	10.000	13
N202UDLOOP 12.0-150	150	12.000	16
N202UDLOOP 12.0-200	200	12.000	16
N202UDLOOP 12.0-250	250	12.000	16
N202UDLOOP 15.0-150	150	15.000	19
N202UDLOOP 15.0-200	200	15.000	19
N202UDLOOP 15.0-250	250	15.000	19
N202UDLOOP 16.0-250	250	16.000	20
N202UDLOOP 18.0-250	250	18.000	22

Filo in Dyneema®

PRODUCT CODE N211

100%
SK75



Braid for special seams that require high tensile strength and low elongation. It slides very easily, is smooth and has an excellent resistance to abrasion and is ideal for the hand sewing of manufactured parts or special splicings. Custom sizes and constructions are also available in addition to those listed.

CONSTRUCTION 100% Dyneema®

Ø	B.L.	ROLL LENGTH
[mm]	[daN]	[m]
0,3	18	300
0,4	50	300
0,6	70	300
0,8	100	300
1	140	300
1,5	230	300

Waxed PRO

PRODUCT CODE N031



High quality waxed braid rolls for professional use. Essential for binding and sewing.

DIAMETERS 1 mm and 1,5 mm

DIAMETER	WEIGHT	LENGTH
[mm]	[g /m]	[m]
1	0,60	500
1,5	1,20	250

COLOURS Solid colour to be chosen between:



Lash Bobbin

PRODUCT CODE N200LB



Used both for running and standing rigging and to obtain optimal distribution of the load on lashings, replacing blocks when the rope undergoes little sliding, such as the vang fall system, backstay fall systems, etc. They can be used with loops, strops and spliced on ropes. Available in different sizes.

CODE	Ø	S. W. L.	THICK-NESS	Ø MAX ROPE	HOLE
	[mm]	[daN]	[mm]	[mm]	[mm]
LB 0	18,6	400	8	5	7,20
LB 1	25	750	10	6	9
LB 2	38	1.500	13	9	15
LB 3	48	3.000	17	11	19
LB 4	55	4.000	20	13	21
LB 5	59	4.500	20	13	25
LB 6	69,6	5.900	31	22	29

Big Bobbin for Loop

PRODUCT CODE N200LBB



The Big Bobbin for Loops differ from the lash bobbins exclusively for the broader measures of the groove, allowing the housing of the loops when in basket configuration (double).

CODE	Ø	S. W. L.	THICK-NESS	Ø MAX ROPE	HOLE
	[mm]	[daN]	[mm]	[mm]	[mm]
LBB 1	38	1.500	18	14	15
LBB 2	48	3.000	24	18	19
LBB 3	55	4.000	29	22	21
LBB 4	59	4.500	30	22	25
LBB 5	69,6	5.900	41	32	29

T-Bone

PRODUCT CODE N210



The T-Bone is an important part in the application of Loops and Stops on board. It is designed to withstand a high load, because of its position in the clash between the two eyes of loop or stop. On request they can be made with titanium or bronze finish to be used on vintage boats. Five sizes available, measured to hold different shear tested breaking loads.

CONSTRUCTION T-Bones are made with 17-4PH steel.

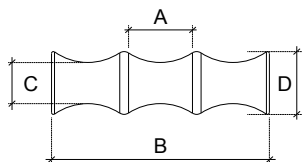

CODE	B.L.	WEIGHT	A	B	C	D
	[daN]	[g / pc]	[mm]	[mm]	[mm]	[mm]
TB 0	1.800	8,00	9	27	5,5	8,5
TB 1	3.000	20,70	13	39	7,5	11,5
TB 2	4.000	28,60	15	45	8,5	13
TB 3	5.000	47,60	18	54	10	15,5
TB 4	9.000	88,40	22	66	12,5	19

Tie Plastic Balls



Balls made of hard plastic, ideal to stop the control lines.

COLOURS

Black - Blue - Green - Red

CODE	EXTERNAL DIAM.	INSIDE DIAM.
	[mm]	[mm]
RF1316BLK	25	5
RF1316BLU	25	5
RF1316GRN	25	5
RF1316R	25	5
RF1317BLK	20	5
RF1317BLU	20	5
RF1317GRN	20	5
RF1317R	20	5
RF1318BLK	16	4
RF1318BLU	16	4
RF1318GRN	16	4
RF1318R	16	4

Halyard Plastic Balls



Balls made of hard plastic, ideal to stop halyards.

COLOURS

Black - Blue - Green - Red

CODE	EXTERNAL DIAM.	INSIDE DIAM.
	[mm]	[mm]
PNP272A	32	15.5
PNP272ABLU	32	15.5
PNP272AR	32	15.5
PNP272AGR	32	15.5
N215440	44	23.5

Coating PU

PRODUCT CODE N213



Water-based polyurethane coating. Solution essential for the protection of ropes without cover. Useful for the application on used ropes or on new ropes that have undergone special working processes and require a further application of protective resin. Suitable to be used on any technical fiber.

Sold in cans of 0,5 and 1,0 litre, it can be diluted in water, depending on the required degree of impregnation.

Application: by brush or immersion with subsequent squeezing of the excess coating and successive open air drying.

Electrical Heat-Cutter

PRODUCT CODE N300



Electric heat-cutter for manual heat cutting of ropes and synthetic ribbons.

Blade, CE conformity declaration and instructions are provided with the product.

Supply voltage: 230 V - 50 Hz

Power input: 60 Watt

Blade temperature: 600 °C reached in about 8 seconds.

Electronic Heat-Cutter

PRODUCT CODE N300_120W

NEW



Electronic heat-cutter for manual heat cutting of ropes and synthetic ribbons, also of big dimensions.

Low weight, reliability, very short heating time.

Blade, CE conformity declaration and instructions are provided with the product.

Supply voltage: 230 V - 50 Hz

Power input: 120 Watt max

Blade temperature: 600 °C reached in less than 6 seconds.

Envelope Containing 5 Needles for Sewing

PRODUCT CODE N303_NEEDLES



Envelope containing 5 needles for bindings and sewing.

Assorted sizes 13 to 19 mm.

10 Needles for Sewing

PRODUCT CODE N307_NEEDLES

NEW



Tube containing 10 needles for sewing. Assorted sizes 14 to 18 mm.

20 Needles for Sewing

PRODUCT CODE N304_NEEDLES

NEW



Tube containing 20 needles for sewing. Assorted sizes 14 to 18 mm.

Sail Repair Kit

PRODUCT CODE N371_REPAIR

NEW



Sail repair Kit comprises: one leather Sewing Palm, one tube of 10 assorted sail needles, waxed sewing thread, beeswax.

Marlin Spikes

PRODUCT CODE N301_MARLIN_175
N301_MARLIN_265



Marlin Spikes for the splicing on strand ropes available in two lengths:

- 175 mm for ropes up to 16 mm diameter
- 265 mm for ropes up to 30 mm diameter.

Splicing Kit Selma

PRODUCT CODE N302_SPLICING-KIT



Splicing kit containing 5 needles made with 316 polished stainless-steel. It can be used for the splicing of single and double braids from diameter 4 to 18 mm. The kit is supplied with instruction.

D-Splicer Set

PRODUCT CODE N302_DSPLICERSET

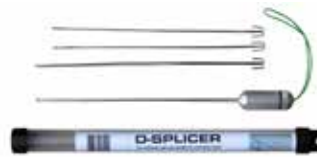

Set made of 4 needles for the splicing of ropes thinner than 5 mm diameter.

F-Series Needel

PRODUCT CODE N302_DISPLICER



Stainless-steel needles, with fixed handle for easy pulling.

- They are available in 3 different sizes:
- F15 mm 1.5: for ropes from 2 to 4 mm
 - F20 mm 2.0: for ropes from 4 to 6 mm
 - F25 mm 2.5: for ropes from 6 to 8 mm

Special Scissors

PRODUCT CODE N300_FORBICI_15
N300_FORBICI_24



Special scissors to cut Dyneema®, Vectran® and Kevlar®.

- They are available in 2 different sizes:
- Scissors blade 15 cm
 - Scissors blade 24 cm

Armare Splicing Tape

PRODUCT CODE N304_TAPE_ARMARE



Armare tape for splicing.

High: 19 mm

Length: 66 m

Multiuse line

Multiuse line

LIFE ON BOARD ASKS FOR DIFFERENT TYPES OF ROPES AS THEY ARE DESTINED TO MULTIPLE USES, E.G. FROM FENDERS TO ANCHORING, FOR STARTING ENGINE OR FOR MOUSING LINES. WITH THE PRODUCTS OF ITS MULTIUSE LINE, ARMARE COVERS ALL KIND OF USE ON BOARD, FOR HANDCRAFTED SOLUTIONS AS WELL AS FOR SEWING. OPTIMUM QUALITY MATERIALS GUARANTEE DURABILITY EVEN WHERE NO SPECIFIC TECHNICAL REQUIREMENTS ARE GIVEN.

MULTIUSE - BREAKING LOAD AND WEIGHT COMPARATIVE TABLE

Ø	FENDER BRAID		FANTASY		PROROPE		SAGOLA		DELPHINUS	
	N021		N009		N010		N016		N013	
DIAM	B. L.	WEIGHT	B. L.	WEIGHT	B. L.	WEIGHT	B. L.	WEIGHT	B. L.	WEIGHT
[mm]	[daN]	[g /m]	[daN]	[g /m]	[daN]	[g /m]	[daN]	[g /m]	[daN]	[g /m]
0,6	-	-	-	-	-	-	29	0,80	-	-
0,8	-	-	-	-	-	-	46	1,10	-	-
1	-	-	-	-	-	-	50	1,60	-	-
1,5	-	-	-	-	-	-	79	2,10	-	-
2	-	-	-	-	-	-	132	3,20	-	-
2,5	-	-	-	-	-	-	143	4,40	-	-
3	-	-	-	-	-	-	192	5,50	-	-
3,5	-	-	-	-	-	-	271	8,60	-	-
4	-	-	320	16,00	200	13,75	320	16,00	200	9,00
4,5	-	-	-	-	-	-	-	-	-	-
5	-	-	400	22,00	350	23,33	400	22,75	-	-
6	-	-	500	30,00	460	28,33	500	30,00	300	14,00
7	-	-	-	-	670	39,27	-	-	-	-
8	1.500	38,00	950	50,00	880	56,75	-	-	400	22,00
9	-	-	-	-	-	-	-	-	-	-
10	1.900	78,00	1.350	75,00	1.200	86,67	-	-	500	33,00
11	-	-	-	-	-	-	-	-	-	-
12	2.150	88,00	1.900	100,00	1.700	120,00	-	-	800	45,00
14	2.630	100,00	2.500	140,00	2.230	160,00	-	-	-	-
16	3.450	112,00	3.300	185,00	3.000	210,00	-	-	-	-
18	-	-	4.200	240,00	3.800	240,00	-	-	-	-

NOTE ABOUT BREAKING LOAD AND DIAMETERS The average values shown above are derived from tests taken at Armare laboratory, with linear ropes, and may change without notice. Other diameters available on request. The static load of the rope must not exceed 20% of breaking load shown in the table. Knots may affect the breaking load of the rope with reductions of up to 60%. The use and exposure to weather conditions, depending from the kind of rope and the time of exposure, can reduce the breaking loads of the ropes.

PET Minirolls

PRODUCT CODE NA38_MIN



CONSTRUCTION 100% Polyester sock.

Core in unidirectional Polyester.

USE Flags, strops, various bindings and sewing.

STANDARD DIAMETERS From 0,8 to 3,5 mm

DIAMETER	B. L.	LENGTH	WEIGHT
[mm]	[daN]	[m]	[g /roll]
0,8	46	50	69,00
1	50	40	60,00
1,5	79	30	63,00
2	132	40	146,00
2,5	143	30	153,00
3	192	20	156,00
3,5	271	15	148,00

STANDARD COLOURS

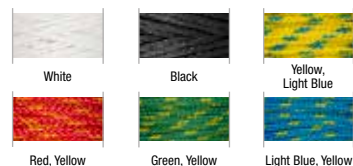

Dyneema® 100% Minirolls

PRODUCT CODE NA67_MIN



CONSTRUCTION 100% Dyneema® braid + PU.

USE Ideal for the hand sewing of manufactured parts or special splicing and for seams that require high tensile strength and low elongation. Very smooth, excellent abrasion resistance. Suggested for kitesurfing, windsurfing and dinghies.

STANDARD DIAMETERS From 0,6 to 1,5 mm

DIAMETER	B. L.	LENGTH	WEIGHT
[mm]	[daN]	[m]	[g /roll]
0,6	70	60	36,00
0,8	100	50	44,00
1	140	40	51,00
1,5	190	30	62,00

STANDARD COLOURS



Dyneema® / PET Minirolls

PRODUCT CODE NA93_MIN



CONSTRUCTION Polyester sock.

Core with unidirectional Dyneema® SK75.

USE For flags, strops, windsurf and various bindings.

STANDARD DIAMETERS From 2 to 3,5 mm

DIAMETER	B. L.	LENGTH	WEIGHT
[mm]	[daN]	[m]	[g /roll]
2	160	15	58,00
2,5	290	10	56,00
3	340	7	50,00
3,5	400	5	51,00

STANDARD COLOURS

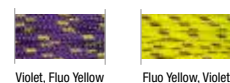

Waxed Braid Minirolls

PRODUCT CODE N026



CONSTRUCTION Waxed Polyester braid.

USE Waxed braid for whipping and sewing.

STANDARD DIAMETERS From 1 to 1,5 mm

DIAMETER	B. L.	LENGTH	WEIGHT
[mm]	[daN]	[m]	[g /roll]
1	-	40	35,00
1,5	-	30	43,00

STANDARD COLOURS



Miniroll Display

PRODUCT CODE N400DISPLAY MINI



DESCRIPTION

Display made of alveolar cardboard with side pocket for flyers. Said display will be supplied free of charge together with the first order placed for a complete set of mini-rolls.

SUCH A SET IS COMPOSED OF:

Code NA38_MIN 10 Mini-rolls Sagola PET HT Coloured - diameters from 2,0 to 3,5 mm

Code NA93_MIN 10 Mini-rolls Braid with Dyneema® SK78 core and PET HT cover - fluorescent colours - diameters from 2,0 to 3,5 mm

Code NA38_MIN 10 Mini-rolls Sagola PET HT White and Black - diameters from 0,8 to 1,5 mm

Code N026 15 Mini-rolls Waxed Braid coloured - diameters 1 and 1,5 mm

Would you please choose and confirm your colours and diameters. Without any specification, delivery will include a standard set (as per picture).

DIMENSIONS

Width 38 cm / Height 50 cm / Depth 41 cm

Fender Braid

PRODUCT CODE N021



CONSTRUCTION 24 plait Polyester braid

CORE None

COVER Polyester

FEATURES AND USE Rope suitable for fenders. It is supple, resistant and has a good knot retention.

STANDARD DIAMETERS From 8 to 16 mm

STANDARD COLOURS



Fantasy

PRODUCT CODE N009



CONSTRUCTION Polyester braid

CORE Twisted Polyester yarn

COVER Polyester

FEATURES AND USE This compact and flexible rope is resistant to UV rays, salt water, solvents and chemical products. It is used for fenders, small moorings, towing, anchors of small boats, blinds, biminies, mooring posts and various bindings. It is not suitable for splicing.

STANDARD DIAMETERS From 4 to 18 mm

STANDARD COLOURS



Prorope

PRODUCT CODE N010



CONSTRUCTION M.T. Polyester braided cover

CORE Twisted Polyester yarn

COVER Polyester

FEATURES AND USE The cheapest and multi-use rope. The compact construction gives to this rope an optimal durability although M.T. Polyester has a tendency to slight rigidity. It is recommended for anchoring of small boats, blinds, anchors of small boats, biminies, mooring posts, various bindings and for the delimitation of sea areas.

STANDARD DIAMETERS From 4 to 18 mm

STANDARD COLOURS



Sagola

PRODUCT CODE N016



CONSTRUCTION Polyester braid

CORE Multifilament Polyester

COVER Polyester

FEATURES AND USE Trim line braided in Polyester. Flexible and durable in sunlight. Suitable for flags, all types of boats, for dinghies as well as for windsurfing, kitesurfing, spear fishing and small bindings.

STANDARD DIAMETERS From 0,6 to 6 mm

STANDARD COLOURS

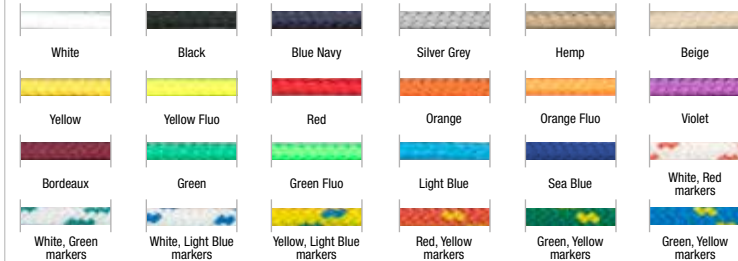

Diameter 0,6 mm only white and black - Colours from 0,8 to 6 mm

Elastic

PRODUCT CODE N014



CONSTRUCTION Braid with core

CORE 100% Pure rubber latex

COVER Polyester

FEATURES AND USE

Resistant to UV rays, to salt and to the bad weather. Having a good duration over time, the elasticity reaches 150 % when new. Used by sailmakers, upholsterer, tarp-maker and on board for sun shade canopies, covers, bindings, tie-rods and much more besides.

STANDARD DIAMETERS From 3 to 10 mm

STANDARD COLOURS



White, Black markers



Black

NEW COLOURS



Red

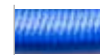

Light Blue



Yellow

Availables only for diameters from mm 3 to 6.

Delphinus

PRODUCT CODE N013



CONSTRUCTION 16 plait braid

CORE None

COVER Polypropylene UV stabilized

FEATURES AND USE Floating rope, supple and resistant. The multifilament yarns makes this rope very supple, preventing the formation of twists and kinks during the use. Fit for all boats and various applications: for life buoys, inflatable life rafts, water skiing, signal buoys and for the delimitation of sea areas.

STANDARD DIAMETERS From 4 to 12 mm

STANDARD COLOURS



White, red markers

Engine

PRODUCT CODE N015



CONSTRUCTION Braid with core

CORE Multifilament Polyester

COVER Compacted made with thermo-fixed Polyester

FEATURES AND USE Flexible and resistant against chafe. Specifically indicated for starting engines.

STANDARD DIAMETERS From 2 to 6 mm

STANDARD COLOURS



White

Multihull Dyneema® Net

PRODUCT CODE RETE_DYN

NEW



CONSTRUCTION Knotless trampoline net, made with 100% Dyneema® impregnated with Polyurethane coating - square mesh.

FEATURES AND USE The best solution for catamarans and trimarans trampoline netting systems. It ensures an easy installation and durability, provides low stretch, low weight, no water absorption and excellent resistance to UV rays and abrasion.

STANDARD SIZE

Available meshes: 15x15 mm / 22x22 mm
Length and width on request. This net is supplied without hemline.

STANDARD COLOUR



White



Silver Grey

Guardrail Net

PRODUCT CODE RETE_60/50

NEW



CONSTRUCTION Braid 2,5 mm in Polyester HT manually knotted - square mesh. Height cm 60 - roll length m 50.

FEATURES AND USE Net usually installed on guard wires to improve safety onboard and preventing children and/or pet falling.

STANDARD SIZE

Roll length 50 m - 40x40 mm mesh

STANDARD COLOUR



White

Other sizes and colours on request.

Armare Shop Rack

PRODUCT CODE N400SHOP RACK

DESCRIPTION

Armare Shop Rack is a new **modular concept** to show Armare rolls in stores. Made of black painted, powder coated steel, thanks to a modular concept, with this rack different compositions can be created, such as in height (**up to 3 times**), laterally or as a corner rack.

Supplied with three bars for the exhibition of rolls as well as with a wall fixing system.

You're kindly required to confirm the desired configuration in order to give us the chance to include all the necessary pieces to compose your Shop Rack.

DIMENSIONS OF BASE MODULE

Width 101 cm

Module Height 108 cm

Banner Armare Height 30 cm

Depth 35 cm



DIMENSIONS OF BASE MODULE



CORNER

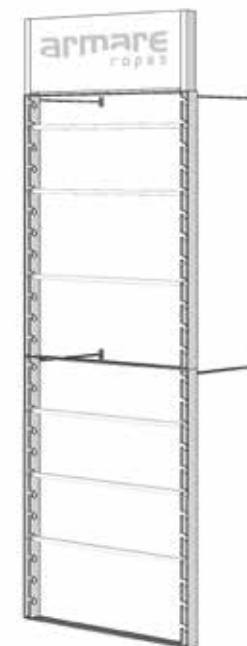

DOUBLE MODULE

Use and safety instructions of the products

Values and technical characteristics published in this catalogue have to be considered purely indicative and are related to brand new ropes, adequately spliced.

The use of knots as well as imprecise or incorrect splicing methods may reduce breaking loads by up to 50%.

Splicing increases the diameter of the rope up to 1,5 times.

As indicated in the margin of every illustrative table, the workload must never exceed 30% of the indicated breaking load.

Ropes under load should never be used in contact with rough surfaces, rust or sharp edges, as this may lead to sudden breakage of the ropes or irreparable damage of the same.

No responsibility can be charged to Armare for damages to people or things caused by an incorrect,

unsafe or improper use of the ropes.

It is suggested rinsing the ropes with soft water (after their removal from the boat) every two to three months or at least at the end of each season. This precaution extends their durability and guarantees a better performance.

All products are subject to changes without prior notice.

Armare declines any responsibility about eventual printing error, e.g. values, descriptions and technical characteristics of the items in this catalogue.



Armare Official Supplier

Armare Ropes, official supplier to FIV
(Italian Sailing Federation)
and supporter of the Italian Olympic Team
as well as of the AICO National Competitive Team.



Look for further Armare Lines



COMPOSITE CABLE AND STANDING RIGGING

Textile rigging remains one of the main development areas, where it is possible to obtain most, in terms of lightness and performance. Armare designs, produces and tests complete solutions for high-tech textile equipment and high performance cables, made with innovative high modulus fibres.

SAILMAKER LINE

Sails have undergone important transformations, especially for what concerns shapes, construction and materials; Sailmakers have the task to choose the accessories that will form the sail and to align them to the performance requirements demanded by their project. Armare's Sailmaker Line has been developed with the contribution of top Sailmakers worldwide. In this catalogue, professionals will find a complete range of items with specific features to supply the needs of the different types of sail they are destined to.

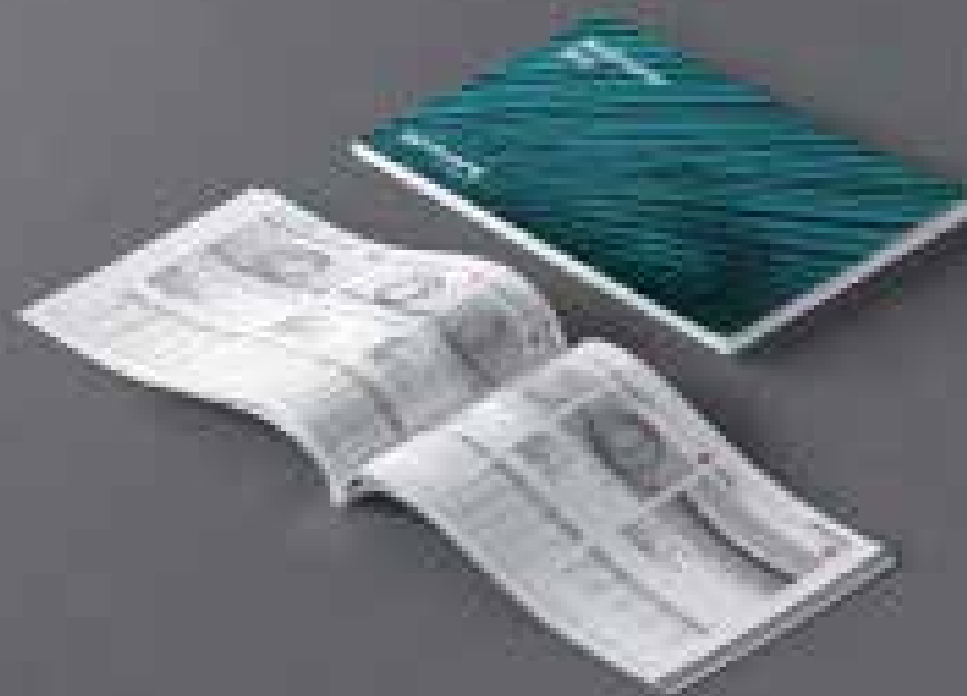

armare
ropes

via Meucci, 3 - Z. I. Aussa Corno
33058 San Giorgio di Nogaro (Udine) - ITALY
T +39 0431 65575 / e-mail: info@armare.it

www.armareropes.com



POR FESR
2014 2020
Friuli Venezia Giulia

OPPORTUNITÀ PER UNA CRESCITA SOSTENIBILE



Designed and Printed in 2019. All rights reserved to Armare s.r.l.

Although the information in this catalogue is presented in good faith and believed to be correct at the time of printing, Armare s.r.l. makes no representations or warranties as to the completeness or accuracy of the information. Armare s.r.l. has no liability for any errors or omissions in the materials. Possession of our price list or literatures does not constitute an offer to sell.

Graphic Design: FiveStudio.it

Photo: Richard Hodder - Emirates Team New Zealand / Hamish Hooper / Nicola Brollo / Andrea Carloni / Luca Cantini / Luca Perna / Gianluca di Fazio / Armare Archive / iStockphoto / Fabio Taccola / Sailing Energy / Martina Orsini / Renato Tebaldi / Matias Capizzano / Andrea Falcon / Elena Giolai / Soluzioni Tessili Rigging / One Palma

armare[®]
ropes

via Meucci, 3 - Z. I. Aussa Corno
33058 San Giorgio di Nogaro (Udine) - ITALY
T +39 0431 65575 / e-mail: info@armare.it

www.armareropes.com

**OFFICIAL
SUPPLIER** 2021
Defender America's Cup 36

